

**REFERENCE**  
**WALKER CARBURETOR**  
**KIT #15251**

**S.U.**

**"APPLICATION"**  
**AUSTIN/MG**  
**HILLMAN/MORRIS**  
**JAGUAR/VOLVO**



**40F**  
**JET GLAND**  
**WASHER**



**120F**  
**CORK JET**  
**GLAND WASHER**

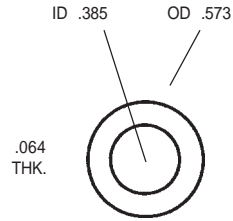

**89F**  
**PIPE CASTING**  
**BOLT WASHER**

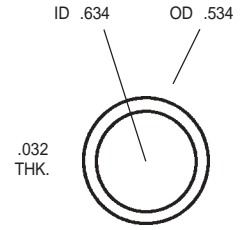

**34F**  
**COPPER TOP**  
**JET WASHER**

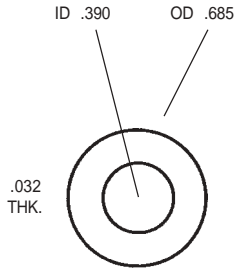

**38F**  
**COPPER BOTTOM**  
**JET WASHER**

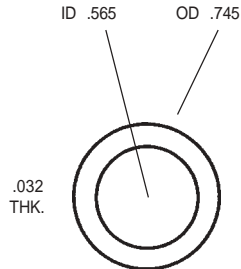

**25F**  
**BRASS SKID**  
**WASHER**

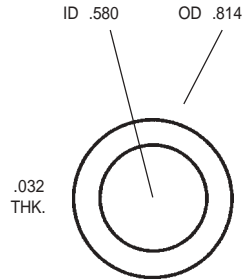

**1248F**  
**FUEL FITTING**  
**WASHER**

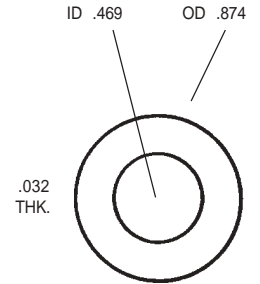

**26F**  
**LOWER BANJO**  
**FITTING WASHER**

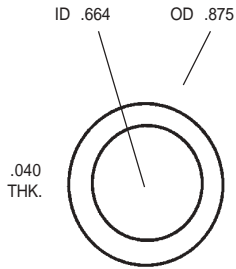

**8F**  
**BANJO BOLT**  
**WASHER**

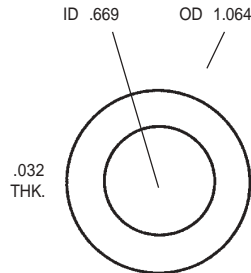

**27F**  
**FIBER WASHER**

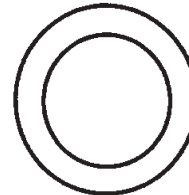

**118F**  
**CORK JET**  
**SEAL RING**

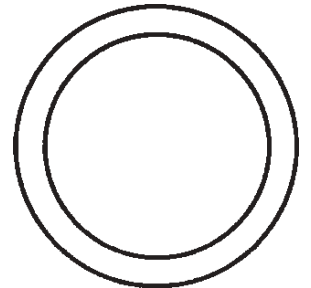

**125F**  
**BOWL COVER GASKET**

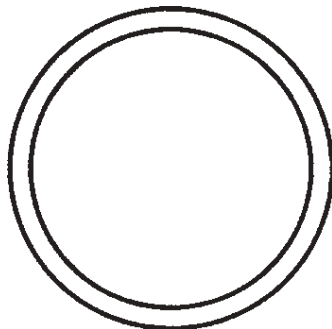

**18F**  
**BOWL COVER GASKET**



**72F**  
**RUBBER**  
**GROMMET**



**31-221**  
**NEEDLE & SEAT**  
**ASSEMBLY**

**REFERENCE**

**WALKER CARBURETOR KITS  
#15578A,15589,15590**

**S.U.**

**"APPLICATION"**

**SEE KIT CATALOG FOR  
SPECIFIC APPLICATIONS**

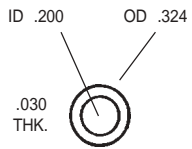

**G1158  
PUMP DISCHARGE  
NOZZLE WASHER**

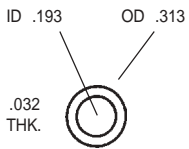

**236F  
NEEDLE VALVE  
WASHER**

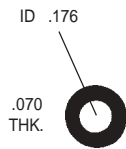

**G273  
SEC. CONNECTING  
TUBE O-RING**

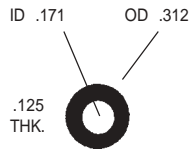

**969F  
RUBBER JET  
LINE WASHER**

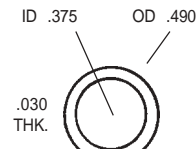

**G52  
DRAIN PLUG  
WASHER**

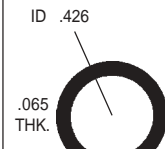

**847F  
FLOAT CHAMBER  
PLUG O-RING**

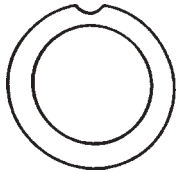

**943F  
COLD START  
VALVE WASHER**

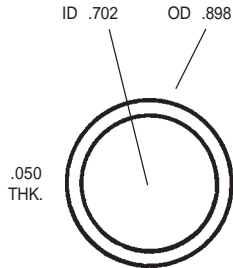

**793F  
MIXING CHAMBER  
TOP WASHER**

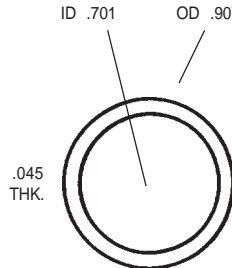

**238F  
FILTER PLUG  
WASHER**

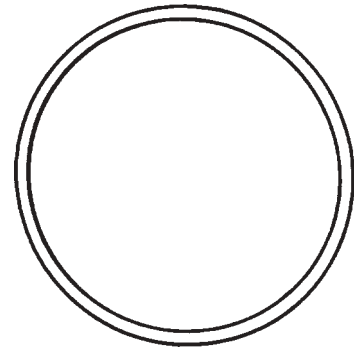

**1214F  
FLOAT CHAMBER  
SEAL**

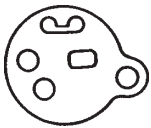

**340F  
HOT START  
VALVE GASKET**

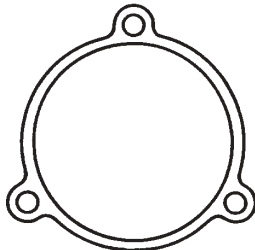

**230F  
BOWL COVER GASKET**

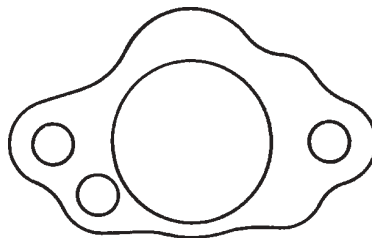

**232F  
AIR CLEANER  
MOUNTING GASKET**

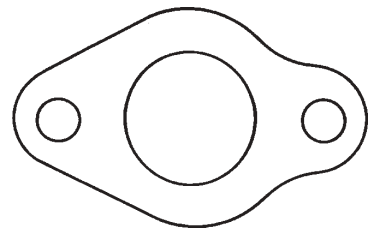

**234F  
FLANGE GASKET**

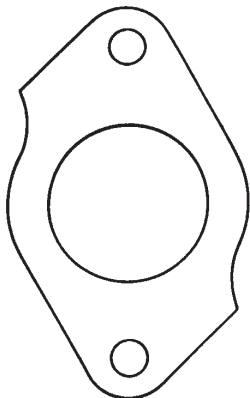

**233F  
FLANGE GASKET**

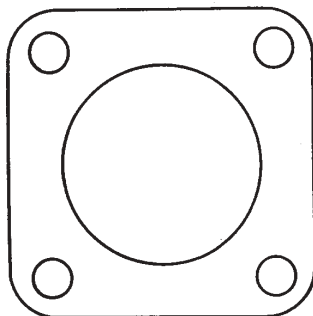

**231F  
FLANGE GASKET**



**31-221  
NEEDLE & SEAT  
ASSEMBLY**

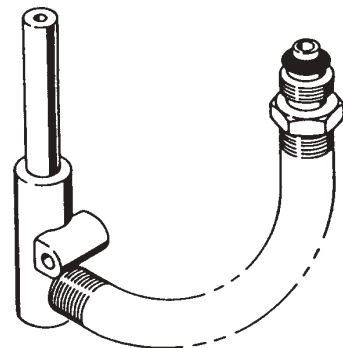

**125-2  
MAIN JET ASSEMBLY**