

CHOKE THERMOSTATS

◆ DESCRIPTION

OPERATES CHOKE BLADE TO ALLOW COLD WEATHER STARTING DUE TO POOR FUEL VAPORIZATION AT COLD TEMPERATURES

◆ SYMPTOMS OF FAILURE

NO START UNDER COLD CONDITIONS, STALLING & HESITATION DURING WARM-UP

◆ RECOMMENDED SERVICE

CHECK FOR PROPER OPERATION, REPLACE WHENEVER CARBURETOR IS REPAIRED

TYPICAL LOCATION

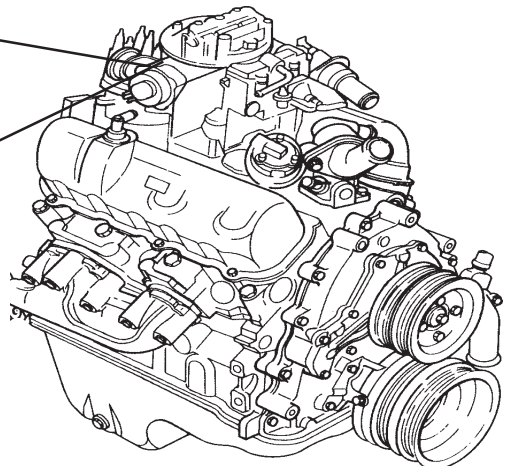
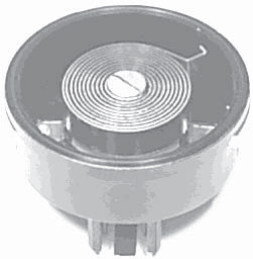

APPLICATION GUIDE

YEAR	VEHICLE MODEL	ENGINE DISP.		MFG. CODE	O.E.M. NO.	WALKER PART NO.
------	---------------	--------------	--	-----------	------------	-----------------

AMC

4 CYLINDER

1979	All Models	2.0L	121"	HW-2	170-1655	102-1058
1980	Concord, Spirit	2.5L	151"	R-2	17061093, 959; 17063188, 17064307	102-1020

6 CYLINDER

1970	All Models	3.3L	199"	C-1	4488063, 4489439	102-1009
1979-70	All Models	3.8L	232"	C-1	4488063, 4489439	102-1009
			(C.T. Tag AH-61, AZ-61)			
1980	4WD	4.2L	258"	C-2	170-1578, 1596; 8132544, 548	102-1050
1979-76	All Models	4.2L	258"	C-2	8127327, 170-1321	102-1028
1979-71	All Models	4.2L	258"	C-1	4488063, 4489439	102-1009

8 CYLINDER

1978-73	All Models	5.0L	304"	F-2	8122959	102-1007
		5.9L	360"			

BUICK

4 CYLINDER

1982	Skyhawk (Inc Calif)	1.8L	112"	R-2	17068690, 17078515, 816	102-1020
1984	Skyhawk	2.0L	121"	R-2	17079669	102-1052
1981-80	Skylark (Inc Calif)	2.5L	151"	R-2	17061093, 959; 17063188, 17064307, 560, 998; 17067728, 17070172	102-1020

6 CYLINDER

1986-80	Century, Skylark (Inc Calif, Canada)	2.8L(X,Z,7)	173"	R-2	17062601, 17063239, 17067579, 580; 17068743, 753; 17079156, 781	102-1020
1985-83	Century, Skylark	2.8L(X)	173"	R-2	17079662	102-1037
1985-82	Century, Electra	3.0L(E)	181"	R-2	17068871, 914	102-1019
1978	All	3.2L(C)	196"	R-2	17054594, 17058794; 17060913	102-1036
1987-82	Century, Electra LeSabre, Regal (Inc Calif)	3.8L(A)	231"	R-2	17068871, 914	102-1019
1987-82	Electra, LeSabre, Regal, Riviera	3.8L (A,3,8,9)	231"(Inc Turbo)	R-4	17068871, 914; 17079035	102-1019
1981-80	Century, Regal, Skylark (Inc Calif)	3.8L(A)	231"	R-2	17064106, 17067329, 437	102-1072
1981-80	Century, LeSabre, Regal, Riviera (Inc Calif)	3.8L(3)	231"	R-4	17064207, 17067329, 437; 17070042	102-1072
1979	Century, LeSabre, Regal, Skyhawk (Inc Calif)	3.8L(A,2)	231"	R-2	17062235, 481	102-1039
1979	Century, LeSabre, Regal, (Inc Calif)	3.8L(3)	231"	R-4	17061327, 17062258, 17063004, 005	102-1039
1978	Century, LeSabre, Regal	3.8L(3)	231"	R-4	7043450	102-1038
1978-77	All Models	3.8L(A,C)	231"	R-2	17054594, 17058794, 17060913	102-1036
1976-75	All Models	3.8L(C)	231"	R-2	17052512	102-1005
1981-80	Century, Electra LeSabre, Regal, Riviera	4.1L(D)	252"	R-4	17064320, 17067329, 437	102-1072
1975	Electra, LeSabre, Regal	4.1L(D)	252"	R-1	17052651	102-1057
1975-73	All Models (W/O Integrated Cylinder Head or Nox Control)	4.1L(D)	250"	R-1	333992, 362710, 3998143	102-1002
1971-68	All Models	4.1L(D)	250"	R-1	3821564, 3927770, 9792129	102-1024

8 CYLINDER

1981	Century, Regal	4.3L(S)	265"	R-2	17067325	102-1019
1980	Century, Regal	4.3L(S)	265"	R-2	17064320	102-1072
1976-75	All Models	4.3L(F)	260"	R-2	17055175, 640	102-1006
1981-80	Century, Electra, LeSabre, Regal, Riviera	4.9L(W)	301"	R-4	17064320, 17067329, 437	102-1072
1979-77	All Models	4.9L(Y)	301"	R-2	17055175, 640	102-1006
1990-82	Electra, Estate Wagon, LeSabre, Regal, Riviera (Inc Closed Loop, Canada)	5.0L(Y)	307"	R-4	17068982, 17110646 W/Carb 17084256, 258	102-1012
1987-86	Regal (Canada)	5.0L(H)	305"	R-4	17110879, 994	102-1019

APPLICATION GUIDE

YEAR	VEHICLE MODEL	ENGINE DISP.	MFG. CODE	O.E.M. NO.	WALKER PART NO.
------	---------------	--------------	-----------	------------	-----------------

BUICK

8 CYLINDER (CONT'D)

1984-81	All Models	5.0L(Y) 307"	R-4	17066792, 17068941	102-1012
1980	Century, Regal (Inc Calif)	5.0L(H) 305"	R-4	17064029, 17070300	102-1019
1979	Skylark (Fed A/T)	5.0L(G) 305"	R-2	17061395	102-1071
1978-77	All Models	5.0L(U) 305"	R-2	17052654, 784	102-1021
1979-77	All Models	5.0L(G,U) 305" 5.7L(L,R,X)350"	R-2, 4	17051918	102-1005
1981-80	All Models	5.7L(B,R,X)350"	R-4	17066792, 17068941	102-1012
1979-75	All Models	5.7L (J,L,R,X) 350"	R-4	7036948	102-1006
1976-75	All Models	5.7L(H) 350"	R-2	17052512	102-1005
1979-77	All Models	6.6L(K) 403"	R-4	17054309	102-1006
1975	All Models	6.6L(S) 400"	R-4	17051995	102-1006
1976-75	All Models	7.5L(T) 455"	R-4	17051964	102-1006

CADILLAC

4 CYLINDER

1982	Cimarron (Inc Calif)	1.8L(G) 112"	R-2	17068690, 17078515	102-1020
------	----------------------	--------------	-----	--------------------	----------

6 CYLINDER

1983-82	Brougham, Deville, Eldorado, Fleetwood, Seville (Inc Calif)	4.1L(4) 252"	R-4	17068871, 914	102-1019
1981	Brougham, Deville, Eldorado, Fleetwood, Seville	4.1L(4) 252"	R-4	17067329, 437	102-1072

8 CYLINDER

1990-86	All Models	5.0L(Y) 307"	R-4	17110646	102-1012
1980	Commercial, Deville, Fleetwood (Calif Only)	6.0L(6) 368"	R-4	17064998	102-1020
1980	Commercial, Deville, Fleetwood (Fed)	6.0L(6) 368"	R-4	17063957, 17064988	102-1072
1979	Commercial, Deville, Fleetwood	7.0L(S) 425"	R-4	17061327, 17062081, 17063004	102-1039
1978-76	All Models	All Engines	R-4	7043450, 17059968	102-1038

CHEVROLET

4 CYLINDER

1977	All Models	1.4L(1) 85"	R-1	17056750	102-1070
1988-80	Chevette (Inc Canada)	1.6L(C,4,9) 98"	HW-2	14022274, 14050672, 14069855	102-1015
1979	Chevette	1.6L(E,O) 98"	H-2	14012911	102-1015
1978	Chevette	1.6L(J) 98"	R-1	17056750	102-1070
1982	Cavalier (Inc Canada)	1.8L(G) 112"	R-2	17068690, 17078515, 816 Exc Carb 17082310, 311, 312, 314, 315	102-1020
1984	Cavalier (Inc Canada)	2.0L(B) 121"	R-2	17079669	102-1052
1976-71	All Models	2.3L(A,B) 140"	R-1, 2	348643, 370707, 6273474, 3998170	102-1060
1981-79	Citation, Monza (Inc Closed Loop, Calif)	2.5L(V,5) 151"	R-2	17061093, 959; 17063188, 17064307, 560, 998; 17067728, 17070172	102-1020
1979-78	Monza (Inc Calif)	2.5L(1) 151"	HW-2	10003440, 441	102-1058
1978	All Models (Exc Calif)	2.5L(1) 151"	HW-2	10003439	102-1058
1970	All Models	2.5L 153"	R-1	3927770	102-1024

6 CYLINDER

1986-80	Camaro, Celebrity, Citation (Inc Calif, Canada)	2.8L (1,7,X,Z) 173"	R-2	17062601, 17063239, 17067579, 580; 17068743, 753; 17079156, 306, 781, 782	102-1020
1984-83	Camaro, (M/T)(Inc Calif)	2.8L(1) 173"	R-2	17078023	102-1052
1983	Celebrity, Citation (Inc Canada)	2.8L(X) 173"	R-2	17079662	102-1037
1980	Camaro, Celebrity, Citation (Inc Canada)	2.8L(7) 173"	R-2	17067207	102-1019

APPLICATION GUIDE

YEAR	VEHICLE MODEL	ENGINE DISP.	MFG. CODE	O.E.M. NO.	WALKER PART NO.
------	---------------	--------------	-----------	------------	-----------------

CHEVROLET

6 CYLINDER (CONT'D)

1979	Malibu, Monte Carlo	3.2L(M)	200"	R-2	17061395	102-1071
1978	All Models	3.2L(C)	196"	R-2	17054594, 17058794	102-1036
1978	Malibu, Monte Carlo (A/T)(Exc Calif)	3.2L(M)	200"	R-2	17057936	102-1038
1971-63	All Models	3.2L	194"	R-1	3821564, 3927770, 772;	102-1024
		3.8L	230"		9783047, 9792129	
		4.1L	250"			
1984-80	Camaro, Malibu, Monte Carlo (Inc Calif)	3.8L(A,K,9)	229"	R-2	17063451, 17064215, 473;	102-1019
					17067495, 17068292, 474, 871, 914	
1981-80	Camaro, Malibu, Monte Carlo, Monza (Inc Calif)	3.8L(A,3)	231"	R-2, 4	17064106, 17067329, 437;	102-1072
				17070042		
1979	Malibu, Monte Carlo, Monza, Nova (A/T)(Hi-Alt)	3.8L(A)	231"	R-2	17062235	102-1039
1978	Malibu, Monte Carlo, Monza, Nova	3.8L(A)	231"	R-2	17060913	102-1036
1978-77	Camaro, Malibu, Monte Carlo, Nova	4.1L(D)	250"	R-1	17056852, 17058954	102-1070
1976-75	All Models	4.1L(D)	250"	R-1	17052651	102-1057
1976-72	All Models	4.1L(D)	250"	R-1	333992, 362710, 3998143	102-1002

8 CYLINDER

1978-75	All Models	4.3L(G)	262"	R-2	17052654, 784	102-1021
		5.0L(G,U)	305"			
		5.7L(H,J)	350"			
1981-80	Camaro, Corvette Malibu, Monte Carlo (Inc Calif)	4.4L(J)	267"	R-2, 4	17063451, 960; 17064029,	102-1019
		5.0L(H)	305"		215, 473; 17067495,	
		(Inc Hi-Perf)			17068292, 474; 17070300	
1979-75	All Models	4.4L(J)	267"	R-2, 4	17051918	102-1005
		5.0L(G,U)	305"			
		5.7L	350"			
		(H,J,L,T,X,4,8)				
		6.6L(U)	400"			
1970-63	All Models	4.6L	283"	R-2	3908966	102-1041
		5.0L	307"			
		5.4L	327"			
		5.7L	350"			
1990-86	All Models	5.0L(Y)	307"	R-4	17110646	102-1012
1988-85	Camaro, Monte Carlo (Inc Canada)	5.0L(H)	305"	R-4	17110879, 994	102-1019
1984-82	All Models	5.0L(H)	305"	R-4	17068956	102-1019
		5.7L(6)	350"			
1980	Camaro	5.0L(T)	301"	R-4	17063392, 17067257	102-1072
1979	All Models (Hi-Alt)	5.0L(H)	305"	R-4	7036948, 17051964, 995;	102-1006
					17054309	
1974-71	All Models	5.0L(F)	307"	R-2	3989058	102-1000
		6.6L(R)	400"			
1970-67	All Models	5.0L	305"	H-4,	3887148, 3972186	102-1040
		5.4L	327"	R-2, 4		
		6.5L	396"			
		7.0L	427"(Inc Hi-Perf)			
1970-67	All Models	5.4L	327"	R-4	3946093, 3973497	102-1001
		5.7L	350"			
		6.5L	396"			
		7.0L	427"			
1967-65	All Models	5.4L	327"	R-4	3887148, 3972186	102-1040
1981-80	Camaro, Malibu, Monte Carlo	5.7L(L,6)	350"	R-4	17063451, 960; 17064029, 215;	102-1019
					17067495, 17068292, 474; 17070300	
1979	All Models	5.7L(L,8)	350"	R-4	7036948, 17051964, 17054309	102-1006
1974-71	All Models	5.7L(J,K,L)	350"	R-4	326079, 3989060, 3998940	102-1002
1970-69	(Inc Camaro Hi-Perf)	5.7L	350"	H-4	3887148, 3972186	102-1040
1970-69	All Models	5.7L	350"	R-2	3887148, 3951638, 3972186	102-1040
1969	All Models	6.5L	396"	R-2	3887148, 3951638, 3972186	102-1040
1969	All Models	6.5L	396"	R-4	3989625, 6272732, 736	102-1054
1967-65	All Models	6.5L	396"	R-4	3887148, 3972186	102-1040

APPLICATION GUIDE

YEAR	VEHICLE MODEL	ENGINE DISP.	MFG. CODE	O.E.M. NO.	WALKER PART NO.
------	---------------	--------------	-----------	------------	-----------------

CHEVROLET

8 CYLINDER (CONT'D)

1974-71	All Models	6.6L(U) 400"	R-4	326079, 3989060, 3998940	102-1002
1974-70	All Models	6.6L(U) 400" 7.4L 454" (W,X,Y,Z)(Hi-Perf)	R-4	3989625, 6272732, 736	102-1054
1970-69	All Models	6.6L 400"	R-2	3887148, 3951638, 3972186	102-1040
1967-65	All Models	7.0L 427"	R-4	3887148, 3972186	102-1040
1976	All Models	7.4L(S) 454"	R-4	17053419	102-1038
1975	All Models	7.4L(Y,Z) 454"	R-4	7036881, 17052640	102-1006

CHEVROLET/GMC TRUCK

4 CYLINDER

1984	All Models	2.0L(Y) 121"	R-2	17079963	102-1052
1983	All Models	2.0L(Y) 121"	R-2	17079107	102-1052

6 CYLINDER

1985-82	S, T-10; T-15	2.8L(B) 173"	R-2	17067727, 17068743, 753; 17078213, 816; 17079306, 782 W/Carb 17082431, 433	102-1020
1983-82	S, T-10; T-15	2.8L 173"	R-2	17068772, 17078012, 023, 530 W/Carb 17082348, 350	102-1052
1979	El Camino	3.2L(M) 200"	R-2	17061395	102-1071
1978	El Camino	3.2L(M) 200"	R-2	17057936	102-1038
1984-80	El Camino	3.8L(K,9) 229" 3.8L(A) 231"	R-2	17063451, 17064215, 473; 17067495, 17068292, 474, 871, 914	102-1019
1981-80	El Camino	3.8L(A,3) 231"	R-2, 4	17064106, 17067329, 437; 17070042	102-1072
1979	El Camino	3.8L(A) 231"	R-2	17062235	102-1039
1978	El Camino	3.8L(A) 231"	R-2	17060913	102-1036
1971-69	All Models	3.8L 230" 4.1L(D) 250" 4.8L(T) 292"	R-1	3927770, 772; 9783047	102-1024
1984-81	C, K, G-10, 20, 30; Blazer (Inc Calif)	4.1L(D) 250"	R-2	17067727, 743; 17068153, 17078213, 816; 17079306, 782 W/Carb 17082431, 433	102-1020
1983-82	C, G-10, 20, 30; K-10 (Inc Calif)	4.1L(D) 250"	R-2	17068772, 17078012, 023, 530 W/Carb 17082348, 350	102-1052
1980	C, G-10, 20; K-10, Blazer	4.1L(D) 250"	R-2	17063693	102-1020
1979	C, G-10, 20, 30; K-10, Blazer	4.1L(D) 250"	R-2	17062957	102-1037
1978-77	C, G, K, P-10, 20, 30; Blazer	4.1L(D) 250"	R-1, 2	17056849, 17058954	102-1070
1978-77	El Camino	4.1L(D) 250"	R-1	17056852, 17058954	102-1070
1976-75	G-10	4.1L(D) 250"	R-1	17052651	102-1057
1976-72	All Models	4.1L(D) 250"	R-1	333992, 362710, 3998143	102-1002
1985	C, G, K-10, 20; G-30, Astrovan (Inc Calif)(Hi-Alt)	4.3L(N) 262"	R-4	17110653, 879, 994	102-1019
1978-77	C, G, K, P-10, 20, 30; Blazer	4.8L(T) 292"	R-1	17056849, 852, 954	102-1070
1976-72	All Models	4.8L(T) 292"	R-1	333992, 362710, 3998143	102-1002
1981-80	El Camino	4.4L(J) 267"	R-2, 4	17063451, 960; 17064029, 215, 473; 17067495, 17068292, 474; 17070300	102-1019
1989-82	C, G-10, 20, 25; K-10, (Inc Hi-Alt)	5.0L(F,H) 305"	R-4	17068988, 17110913, 960	102-1019
1988-85	El Camino	5.0L(H) 305"	R-4	17110879, 994	102-1019
1981	C, G-10, 15, 20	5.0L(G) 305"	R-2	17067495, 17068292, 474	102-1019
1981-80	El Camino	5.0L(H) 305"	R-2, 4	17063451, 960; 17064029, 215, 473; 17067495, 17068292, 474; 17070300	102-1019
1980	(Stamped 63815, 64067)	5.0L(G,H) 305" 5.7L(L,M) 350"	R-2, 4	17066642, 694	102-1061

APPLICATION GUIDE

YEAR	VEHICLE MODEL	ENGINE DISP.	MFG. CODE	O.E.M. NO.	WALKER PART NO.
------	---------------	--------------	-----------	------------	-----------------

CHEVROLET/GMC TRUCK

8 CYLINDER (CONT'D)

1979-77	All Models	5.0L(H,U) 5.7L(L,M) 6.6L(R)	305" 350" 400"	R-2, 4	17051918	102-1005
1978-75	All Models	5.0L(Q,U)	305"	R-2	17052654, 784	102-1021
1974-71	All Models	5.0L(Y) 5.7L(V)	307" 350"	R-2	3989058	102-1000
1971-68	All Models	5.4L 5.7L 6.5L	327" 350" 396"	R-4	3946093, 3973497	102-1001
1988-83	C, G-10, 20; K-10 (Inc Hi-Alt)	5.7L (K,L,M)	350"	R-4	17068988, 17110960	102-1019
1985-83	C, K, P-20, 30; G-30 (Inc Hi-Alt)(4WD)	5.7L(L,M)	350"	R-4	17078726	102-1073
1981-80	El Camino	5.7L(L,6)	350"	R-4	17063451, 960; 17064029, 215; 17067495, 17068292, 474; 17070300	102-1019
1980	All Models	5.7L(M) 6.6L(R,X) 7.4L(S,W)	350" 400" 454"	R-4	17066631, 634	102-1012
1980-76	All Models	5.7L(L,M) 7.4L(S,W,Y)	350" 451"	R-4	7036881, 948; 17051964, 995; 17052640	102-1006
1978-77	All Models	5.7L(L,M) 6.6L(R)	350" 400"	R-4	460110	102-1011
1978-75	All Models	5.7L(L,M) (W/Integral Style)	350"	R-4	17052654, 784	102-1021
1978-71	All Models	5.7L(L,Y) 6.6L(M,U)	350" 400"	R-4	326079, 3989060, 3998940	102-1002
1971-70	All Models	6.5L	396"	R-4	3969825, 6272732, 736	102-1054
1980	All Models	6.6L(R,X)	400"	R-4	17066642, 694	102-1061
1980-76	All Models	6.6L(R,X) 7.4L(S,W,Y)	400" 454"	R-4	7036881, 948; 17051964, 995; 17052640	102-1006
1976-73	All Models	6.6L(M,U)	400"	R-4	3969825, 6272732, 736	102-1054
1990-81	C, G-10, 20; K-10 (Inc Hi-Alt)	7.4L(W)	454"	R-4	17068988, 17110960	102-1019
1984	C, K, P-20, 30 (Calif)	7.4L(W)	454"	R-4	17110157	102-1012
1977-75	C-10	7.4L(S,Y,Z)	454"	R-4	17053419	102-1038
1976-70	All Models (Inc Motor Home)	7.4L(Y,Z)	454"	R-4	3969825, 6272732, 736	102-1054
1969	All Models	All	(LP Gas)	R-2	3951638	102-1040

CHRYSLER

4 CYLINDER

1984-82	All Models	2.2L(C)	135"	H-2	4186295	102-1013
---------	------------	---------	------	-----	---------	----------

6 CYLINDER

1984-77	All Models	3.7L(D) (C.T. Tag AV-1488)	225"	C-2	4027707, 4095337	102-1049
1984-77	All Models (Inc Calif)	3.7L (C,E,F,H,J)	225"	H-1	4027705, 4095330, 332, 336; 4213715	102-1022
1980	All Models (Inc Canada)	3.7L(C)	225"	C-2 (BBD)	4095328	102-1003

8 CYLINDER

1989-85	All Models (Exc Canada)	5.2L(P,4)	318"	H-2	4095339	102-1004
1984-75	All Models	5.2L (G,K,L,P,4) 5.9L(K)	318" 360"	C-2	3830512, 4027711, 4095338, 170-982, 1332, 1489 W/Carb 8291	102-1004
1983-80	All Models	5.2L (G,K,L,P)	318"	C-2	4095329, 170-1599 W/Carb 8292, 8369	102-1004
1982-81	All Models (Inc Calif, Canada)	5.2L(M,N) (C.T. Tag BP 1621)	318"	C-4	3751484, 3830548, 4027715, 4095328, 331, 341, 984; 170-861, 980, 1408, 1675	102-1003
1980-73	All Models	5.2L(G) 5.9L(K) 6.6L(M)	318" 360" 400"	H-2	3698371, 3751480, 4027713, 4041834, 4095339, R-6416, R-6680, 82; R-7638AAA, R-7992A, 45-244	102-1004

APPLICATION GUIDE

YEAR	VEHICLE MODEL	ENGINE DISP.	MFG. CODE	O.E.M. NO.	WALKER PART NO.
------	---------------	--------------	-----------	------------	-----------------

CHRYSLER

8 CYLINDER (CONT'D)

1979-78	All Models (Non-electric)	5.2L(G)	318"	C-2	3751479, 170-857	102-1014
1980-79	All Models (Inc Calif, Canada)	5.9L(J)	360"	C-4	3751484, 3830548, 4027715, 4095328, 331, 341, 984; 170-861, 980, 1408, 1675	102-1003
1975	All Models (Non-electric)	5.9L(K)	360"	H-2	3751481, R-6681A	102-1014
1972-71	All Models	5.9L(K)	360"	H-2	3512872, R-4654	102-1043
		6.6L(M)	400"			
1978-74	All Models	6.6L(N)	400"	C-4	3751484, 3830548, 4027715, 4095328, 331, 341, 984; 170-861, 980, 1408, 1675	102-1003

CHRYSLER IMPORT

4 CYLINDER

1990-80	All Models	(Small Diameter Choke)		MI-SL		85-351
1990-80	All Models	(Large Diameter Choke)		MI-SL		85-350

DODGE

4 CYLINDER

1980	Aries, Charger, Omni (Inc Calif, Canada)	1.6L(K)	98"	H-2	4186295, 4240080, 4342867, 868	102-1013
		1.7L(A)	105"			
1979-78	Omni	1.7L(A)	105"	HW-2	4131132	102-1058

6 CYLINDER

1969-62	All Models	2.7L(A)	170"	C-1	2402526, 2658396, 170-760, 867	102-1042
		3.7L(B)	225"			
1969-62	All Models	2.7L(A)	170"	H-1	2532568, 2658398, R-3052A, R-3283-2A	102-1042
		3.7L(B)	225"			
1973	All Models	3.2L(B)	198"	H-1	3698351, R-6434-1A	102-1056
		3.7L(C)	225"			
1972-70	All Models	3.2L(B)	198"	H-1	3614111, 112; R-6222A	102-1025
		3.7L(C)	225"			
1983-74	All Models	3.7L (C,E,F,H,J)	225"	H-1	3751476, 3830549, 4006669, 4027705, 4095330	102-1022
1980	All Models (Inc Canada)	3.7L(D)	225"	C-2	4095328	102-1003
1980-77	All Models	3.7L(D)	225"	C-2	4027707, 4095337, 170-1331, 1488	102-1049

8 CYLINDER

1989-85	All Models (Exc Canada)	5.2L(P,4)	318"	H-2	4095339	102-1004
1984-73	All Models	5.2L (G,K,L,P,R,4)	318"	C-2	3698353, 3830512, 4027711, 4095338, 170-266, 982, 1332 W/Carb 8291	102-1004
		5.9L(K)	360"			
1983-80	All Models (Exc Calif)	5.2L (G,K,L,P,4)	318"	C-2	4095329 W/Carb 8292, 8369	102-1004
1981	All Models (Inc Calif, Canada)	5.2L(M,N) (C.T. Tag BP 1621)	318"	C-4	3751484, 3830548, 4027715, 4095331, 341, 984; 4095331, 170-861, 980, 1408, 1675	102-1003
1980	All Models (Inc Calif)	5.2L(G)	318"	C-2	4095328	102-1003
	All Models (Exc Calif)	5.9L(K)	360"			
1979-74	All Models (Non-electric)	5.2L(G)	318"	C-2	3751479, 170-857	102-1014
1979-73	All Models	5.2L(G)	318"	H-2	3698371, 3751480, 4027713, 4041834, 4095339, R-6416, R-6680-1A, 82A; R-7638AAA, 45-244	102-1004
		5.9L(K)	360"			
		6.6L(M)	400"			
1978-75	All Models (Non-electric)	5.2L(G)	318"	H-2	3751481, R-6681A	102-1014
1972-70	All Models (Inc Export)	5.2L(G)	318"	C-2	2946535, 2951651, 170-222, 232	102-1026
1971-70	All Models	5.6L(J)	340"	H-2	3614197, R-6199A, 1A	102-1046
1980-74	All Models	5.9L(J,L)	360"	C-4	3751484, 3830548, 4027715, 4095331, 341, 984; 170-861, 980, 1408, 1675	102-1003
1972-71	All Models	5.9L(K)	360"	H-2	3512872, R-4654A, 1A	102-1043
		6.2L(L)	383"			
		6.6L(M)	400"			

APPLICATION GUIDE

YEAR	VEHICLE MODEL	ENGINE DISP.	MFG. CODE	O.E.M. NO.	WALKER PART NO.
------	---------------	--------------	-----------	------------	-----------------

DODGE

8 CYLINDER (CONT'D)

1978-73	All Models (Inc Calif, Canada)	6.6L(N,P) 400" 7.2L(T,U) 400" (C.T. Tag BP 1621)	C-4	3751484, 3830548, 4027715, 4095331, 341, 984; 170-861, 980, 1408, 1675	102-1003
---------	-----------------------------------	--	-----	--	----------

DODGE TRUCK

4 CYLINDER

1988-84	All Models	2.2L(C,F,8) 135"	H-2	4186295, 4240080, 4342868, 4549204	102-1013
---------	------------	------------------	-----	---------------------------------------	----------

6 CYLINDER

1969-65	All Models (Exc Calif)	2.7L(A) 170" 3.7L(C) 225"	H-1	2532568, 2658398, R-3052A, R-3283-2A	102-1042
1969-62	B-100, 200, 300, D-W100	2.7L(A) 170" 3.7L(C) 225"	C-1	2402526, 2658396, 170-760, 867	102-1042
1971-70	B-100, 200, 300, D-W100	3.2L(A) 198" 3.7L(C) 225"	H-1	3614111, R-6222A	102-1025
1987-74	All Models	3.7L(E,H) 225"	H-1	3751476, 3830549, 4006669, 4027705, 4095330, 332, 335; 4213715	102-1022
1983-78	All Models	3.7L 225" (B,M,W)	C-2	4027707, 4095337, 170-1331, 1488 Exc Carb 8176	102-1049
1983-77	All Models	3.7L 225" (B,M,W)	C-2	4041600, 170-1348 W/Carb 8176	102-1062
1973	B-100, 200, 300, D-W100	3.7L(C) 225"	H-1	3698351, R-6434-1A	102-1056

8 CYLINDER

1987-74	All Models	5.2L(E,P,T) 318" 5.9L(F,S,V) 360" 6.6L(J) 400"	H-2	3751480, 482; 4027713, 4095339, R-6680-1A, 82A; R-7638AAA, 45-244	102-1004
1986-81	All Models	5.2L(R,S,U) 318" (C.T. Tag BT 1490)	C-4	3830548, 4027714, 715; 4095331, 341; 170-980, 1334, 1408, 1621	102-1003
1984-77	All Models	5.2L 318" (E,P,R,T)	C-2, 4	4041597, 170-1371	102-1014
1983	All Models (Hi-Alt)	5.2L(T) 318" (C.T. Tag AX1599)	C-2	4095329, 170-1599	102-1004
1983-74	All Models	5.2L(E,P,T) 318"	C-2	3830512, 4027711, 170-1489	102-1004
1983-74	All Models (W/O Wire)	5.2L(E,P,T) 318" 5.9L(F,S,V) 360" 6.6L(J) 400"	H-2	3751481, 4095450, R-6681A, R-8183A	102-1014
1980-78	All Models (W/O Wire)	5.2L 318" 5.9L 360" 7.2L 440" (C.T. Tag BT 1049)	C-4	4027795, 170-1409	102-1077
1974-70	B-D-W 100, 200, 300; D1, 2, 3; BL-2, B-3 Sport; W2, 3 (Inc Export)	5.2L(E) 318" 6.2L(J) 383"	C-2	2946535, 2951651, 170-222, 232	102-1026
1973	B-300 Wagon (Exc 15 Pass.) B-100, 200, D-W-100	5.2L(E) 318"	C-2	3698353, 170-266	102-1004
1986-81	All Models	5.9L 360" (U,V,W)	C-4	3830548, 4027714, 715; 4095331, 341; 170-980, 1334, 1408, 1621	102-1003
1984-77	All Models	5.9L 360" (F,S,U,V,W)	C-2, 4	4041597, 170-1371	102-1014
1973	D-W-100, 400; B-D-100, 200, 300	5.9L(F) 360"	H-2	3698371, R-6416	102-1004
1972-71	B-D-W 100, 200, 300, 400; D-100, 200, 300	5.9L(F) 360"	H-2	3512872, R-4654A, 1A	102-1043
1980-78	All Models	7.2L(D) 440" (C.T. Tag BT 1490)	C-4	3830548, 4027714, 715; 4095331, 341; 170-980, 1334, 1408, 1621	102-1003
1974	D-A-100	7.2L(A) 440"	C-4	3751484, 170-861	102-1003

APPLICATION GUIDE

YEAR	VEHICLE MODEL	ENGINE DISP.	MFG. CODE	O.E.M. NO.	WALKER PART NO.
------	---------------	--------------	-----------	------------	-----------------

FORD

4 CYLINDER

1985-84	All Models (All Tran.)	1.6L(2) 98" (C.T. Tag 47R-711-1A, 3A, 4A)	W-2	E4PZ-9848-B, C, D	102-1069
1983-82	All Models (All Tran.) (Inc Canada)	1.6L(2,4) 98" (C.T. Tag 47R-688A, 1A; 706-1A, 2A, 3A, 4A)	W-2	E3PZ-9848-H, K, L, M	102-1035
1982-81	All Models (All Tran.)	1.6L(2,4) 98" (C.T. Tag 47R-674A, 1A)	W-2	E1PZ-9848-C, G	102-1029
1985-84	All Models	2.3L(R) 140" (HSC) (C.T. Tag 47R-696-4A)	H-1	E4PZ-9848-A	102-1034
1985-83	All Models (All Tran.)	2.3L(R) 140" (C.T. Tag RER3-06HS, 48HS)	C-1	E3PZ-9848-J, E4PZ-E	102-1032
1982-80	All Models	2.3L(A) 140"	H-2	E0PZ-9848-C, D	102-1023
1981-77	All Models (Inc Calif)	2.3L(A,Y) 140"(Turbo)	H-2	D8PZ-9848-D, E7FZ-A, E7PZ-A, 170-1528	102-1063

6 CYLINDER

1979-74	All Models (All Tran.) (Inc Calif)	2.8L(P,Z) 171" (VV) (C.T. Tag 2AB4, 2EB4, 2FB4, 2LB4, 26B4)	F-2	D3AZ-9848-N, D5AZ-A, C; D5OZ-A, D7FZ-E	102-1008
1978-77	All Models (Inc Calif)	2.8L(Z) 171" (VV) (C.T. Tag 7-85MF)	F-2	D7ZZ-9848-E	102-1066
1974-70	All Models	2.8L(U) 170" 3.3L(T) 200" 3.9L(V) 240" 4.1L(L) 250" (C.T. Tag U877, AJ877, AZ877)	C-1	D0DZ-9848-A, D0TZ-A, B; 170-1102, 04, 08	102-1010
1969-63	All Models	2.8L(U) 170" 3.3L(T) 200" (C.T. Tag TP)	F-1	C5OZ-9848-A	102-1031
1983-82	All Models (Inc Canada)	3.3L(X,B) 200" (C.T. Tag 47R-686-3A)	H-1	E2PZ-9848-K	102-1033
1982-78	All Models (All Tran.)	3.3L(B,T) 200"	H-1	E0PZ-9848-F, K; E1PZ-F, 45-266	102-1064
1980-78	All Models (All Tran.)(Inc Calif)	3.3L(B,T) 200" (C.T. Tag EC1548A, ED1546A, 1545A)	C-1	D8PZ-9848-B, D9PZ-A, B, C; E0PZ-G, H; 170-1545, 46, 48, 53, 76	102-1065
1979-78	All Models (All Tran.)	3.3L(B,T) 200" (C.T. Tag 1-70L-J)	H-1	D8PZ-9848-E, D9PZ-F	102-1051
1978-74	All Models	3.3L(T) 200" 4.1L(L) 250" (C.T. Tag EC901A)	C-1	D4DZ-9848-C, D4TZ-E, 170-1232, 39	102-1027
1977	All Models	3.3L(T) 200" 4.1L(L) 250" (C.T. Tag AZ877, U877)	C-1	D0DZ-9848-A, D0TZ-A, B; 170-1102, 04, 08	102-1010
1986-85	All Models (Exc Canada)	3.8L(3) 232"	EFI	E35Y-9848-A	102-1017
1984-82	All Models (Inc Calif, Canada)	3.8L(C,3) 232" (C.T. Tag 2065KE350, 2080ME350, 400)	F-2	E2TZ-9848-A, E3SZ-B, E3TZ-B	102-1018
1982	All Models (Inc Calif)	3.8L(3) 232" (VV) (C.T. Tag 7090KD400)	F-2	E2DZ-9848-A	102-1017

8 CYLINDER

1983-80	All Models	4.2L(D) 255" 5.0L(F) 302" (C.T. Tag 2065ME350, 2080ME350, 2100ME400)	F-2	E0BZ-9848-B, E1BZ-E, E2BZ-D	102-1008
1980-60	All Models	3.6L 221" 4.3L 260" 4.7L(C) 289" 5.0L(F) 302" 5.8L(G,H,Q)352" 6.4L(Y) 390" (C.T. Tag TB3, TB4, TB5, TW, TX, TY)	F-2	C6AZ-9848-A, D0AZ-G, D1AZ-A, B, C; D2AZ-B	102-1007

APPLICATION GUIDE

YEAR	VEHICLE MODEL	ENGINE DISP.	MFG. CODE	O.E.M. NO.	WALKER PART NO.
------	---------------	--------------	-----------	------------	-----------------

FORD

8 CYLINDER (CONT'D)

1991-81	All Models (A40D)	4.2L(D) 255"(VV) 5.0L(F,T) 302" 5.8L(G) 351"(VV) (C.T. Tag 7090KD400, C100ME-4)	F-2, TBI	E1AZ-9848-E, E35Y-A, E5AE-EA	102-1017
1974-60	All Models	4.7L(A) 289" 5.0L(G) 302" 5.8L(R,Q) 351" 6.4L(S) 390" 7.0L(O) 429" 7.0L(R,Q) 428" 7.5L(A) 460" (C.T. Tag TN, TO, 4TY)	F-2, 4	C4AZ-9848-A, B; D0AZ-D	102-1007
1971-65	All Models	4.7L(A) 289" 5.0L(D,F) 302" 5.8L(M) 351" 5.8L 352"	H-4	B8A-9848-E, 47R-116A	102-1068
1985-83	All Models (Inc Canada)	5.0L(M) 302"	F-2	E3AZ-9848-D	102-1018
1985-83	Mustang (M/T)	5.0L(M) 302" (C.T. Tag 47R-764A)	H-4	E3PZ-9848-N, E4PZ-G	102-1075
1981-77	All Models (Inc Calif)	5.0L(F) 302"(VV) 5.8L(G,H,Q)351"(VV) (C.T. Tag 7-40MF, 7-85MF, 7060KH350, 7090KE375)	F-2	D7ZZ-9848-A, E; D9AZ-D, E0AZ-G	102-1066
1980-73	All Models (Inc Hi-Alt)	5.0L(F) 302" 5.8L(G,H,Q)351" 6.6L(S) 400" (C.T. Tag 2AB4, 2EB4, 2FB4, 2LB4, 26B4, 2-65MF, 2-500E, 2-650D, 2100ME)	F-2	D3AZ-9848-N, D5AZ-A, C; D5OZ-A, D7AZ-A, D; D7DZ-A, D7TZ-A, D84Z-A	102-1008
1983-80	All Models	5.8L(G) 351"(VV) (C.T. Tag 7080KD375)	F-2	E0AZ-9848-L	102-1067
1980	All Models	5.8L(G) 351"(VV) (C.T. Tag EOAE-HA)	F-2	E0AZ-9848-D	102-1080
1978-74	All Models	7.4L(A,C) 460" (C.T. Tag 2AB4, 2EB4, 2FB4, 4AB5)	F-4	D3AZ-9848-N, D5AZ-A, D5VZ-C	102-1008

FORD TRUCK

4 CYLINDER

1986-83	All Models (M/T)	2.0L(C) 122" (C.T. Tag REL-50HS)	C-1	E3PZ-9848-B	102-1032
1983	All Models (M/T, All Tran. 2WD)	2.0L(C) 122" (C.T. Tag REL-29HS, 31HS, 33HS)	C-1	E3PZ-9848-A, C, D	102-1053
1986-83	All Models	2.3L(A) 140" (C.T. Tag REL-50HS)	C-1	E3PZ-9848-B	102-1032
1983	All Models (All Tran.)(2WD)	2.3L(A) 140" (C.T. Tag REL-29HS, 31HS, 33HS)	C-1	E3PZ-9848-A, C, D	102-1053

6 CYLINDER

1986-82	Aerostar, Bronco II, Ranger, F-100	2.8L(S) 171" 3.8L(3) 232" (C.T. Tag 2080ME350, 2080ME400, 2100MF400, P6065ME)	F-2	E2TZ-9848-A, E3TZ-B, G; E3UZ-A	102-1018
1986-70	All Models	2.8L(S) 170" 3.9L(A) 240" 4.9L(E,Y) 300" (C.T. Tag AJ877, AZ877, U877)	C-1	D0DZ-9848-A, D0TZ-A, B; D4PZ-Z, 170-1102, 04, 08	102-1010
1983	All Models (M/T)	3.8L(3) 232" (C.T. Tag TB4)	F-2	D1AZ-9848-B	102-1007
1986-82	All Models	4.9L(E,Y) 300" (C.T. Tag EB-W15A,EC-W16A)	C-1	E2PZ-9848-J, E3PZ-F	102-1016
1982	All Models (M/T) (Exc Calif)(Inc Hi-Alt)	4.9L(E,Y) 300" (C.T. Tag EM-44HS)	C-1	E2PZ-9848-F	102-1016

APPLICATION GUIDE

YEAR	VEHICLE MODEL	ENGINE DISP.	MFG. CODE	O.E.M. NO.	WALKER PART NO.
------	---------------	--------------	-----------	------------	-----------------

FORD TRUCK

6 CYLINDER (CONT'D)

1981	All Models (All Tran.)	4.9L(Y) 300" (C.T. Tag EB1672A, EC1673A)	C-1	E1PZ-9848-A, E; 170-1672, 73	102-1030
1980	All Models (Exc E & F-350)	4.9L(E) 300"	C-1	170-1079 W/Carb 7342, 61, 7416	102-1009
1980-78	All Models	4.9L(B,C,E)300" (C.T. Tag EB1544A, EC1545A)	C-1	D8PZ-9848-A, B; D9PZ-A, D; 170-1428, 1544, 45, 46 W/Carb 7347, 50	102-1065
1978-74	All Models	4.9L(B,C) 300" (C.T. Tag EB901A, EC901A)	C-1	D4DZ-9848-C, D4TZ-E, 170-1232, 39	102-1027

8 CYLINDER

1985-70	All Models	5.0L(F) 302" 5.8L(G) 351" 5.9L(Y) 360" 6.4L(H) 390" 6.6L(S,Z) 400" (C.T. Tag TB3, TB4, TB5, TW, TX)	F-2	C6AZ-9848-A, D0AZ-G, D1AZ-A, B, C	102-1007
1984-83	All Models (All Tran.)	5.0L(F) 302" (C.T. Tag 2100KH, 2100MF, 2100MF400)	F-2	E3TZ-9848-A, D; E3UZ-A	102-1018
1983-81	All Models (Inc Calif)	5.0L(F) 302" (VV) 5.8L(G) 351" (VV) (C.T. Tag 7080KD375, 7120KD400)	F-2	E0AZ-9848-L, E2TZ-C	102-1067
1983-73	All Models	5.0L(F) 302" 5.8L(H,M,G)351" 6.6L(S,Z) 400" (C.T. Tag 2AB4, 2EB4, 2FB4, 2LB4, 2-55MD, 2-65MF, 2-650D, 2-850D, 26B4, 2100ME, 2120MF, T2DP)	F-2	D3AZ-9848-N, D4TZ-A, D5AZ-A, C; D5OZ-A, D7AZ-A, D7FZ-E, D7TZ-A, D84Z-A, D9UZ-A, E0DZ-A	102-1008
1982	All Models (Hi-Alt)	5.0L(F) 302" (C.T. Tag 2100ME450, 2120MF525)	F-2	E2AZ-9848-B, E2TZ-D	102-1008
1980	All Models (A/T)(Exc Calif, Canada)	5.0L(F) 302" (C.T. Tag 2100ME8)	F-2	E0TZ-9848-A	102-1008
1986-84	All Models	5.8L(G,H) 351" 7.5L(L) 460"	H-4	E4PZ-9848-F, E5PZ-B, E6PZ-B	102-1075
1983	E100, E250 (Inc Hi-Alt)(A/T)	5.8L(W) 351"	F-2	E3TZ-9848-F	102-1018
1975	All Models	6.4L(M) 390"	H-4	B8A-9848-E, 47R-116A	102-1068
1985-83	All Models	7.5L(L) 460"	H-4	E3PZ-9848-E	102-1074
1982-74	All Models	7.5L(A,J) 460"	H-4	B8A-9848-E, 47R-116A	102-1068
1978-73	All Models (Calif)	7.5L(A) 460" (C.T. Tag 4AB5)	F-4	D5VZ-9848-C	102-1008
1975-74	All Models	7.5L(A,J) 460" (C.T. Tag 4TY)	F-4	D0AZ-9848-D	102-1007

JEEP

4 CYLINDER

1980	CJ-5, CJ-7	2.5L(B) 151"	R-2	17061093, 959; 17063188, 17064307	102-1020
------	------------	--------------	-----	-----------------------------------	----------

6 CYLINDER

1986-84	All Models	2.8L(W) 173"	R-2	89 83 501 018	102-1052
1986-84	XJ Models	2.8L(W) 173"	R-2	17078816	102-1020
1978-72	All Models	3.8L(E) 232" 4.2L(A) 258" (C.T. Tag AH61, AZ61)	C-1	4488063, 4489439, W/Carb 7039, 43, 83, 88	102-1009
1980	4WD	4.2L(C) 258"	C-2	8132544, 548; 170-1578, 1596	102-1050
1979-77	All Models	4.2L(C) 258"	C-2	8127327, 170-1321	102-1028

8 CYLINDER

1979-73	All Models	5.0L(H) 304" 5.9L(N) 360"	F-2	8122959 W/Carb 8DA2J, 8DM2, 8DM2C	102-1007
---------	------------	------------------------------	-----	--------------------------------------	----------

APPLICATION GUIDE

YEAR	VEHICLE MODEL	ENGINE DISP.	MFG. CODE	O.E.M. NO.	WALKER PART NO.
------	---------------	--------------	-----------	------------	-----------------

LINCOLN

6 CYLINDER

1983	All Models (Inc Calif, Canada)	3.8L(3) 232" (C.T. Tag 2065KE350, 2080ME350, 400)	F-2	E2TZ-9848-A, E3SZ-B, E3TZ-B	102-1018
1982	All Models (Inc Calif)	3.8L(3) 232" (C.T. Tag 7090KD400)	F-2	E2DZ-9848-A	102-1017

8 CYLINDER

1967-65	All Models	4.7L(A,K) 289"	H-4	B8A-9848-E, 47R-116A	102-1068
1991-81	All Models (A4OD)	5.0L(F) 302"(VV) (C.T. Tag 7090DK400, C100ME-4)	F-2,TBI	E1AZ-9848-E, E35Y-A, E5AE-EA	102-1017
1980	All Models	5.0L(F) 302" (C.T. Tag 2065ME350, 2080ME350, 2100ME400)	F-2	E0BZ-9848-B, E1BZ-E, E2BZ-D	102-1008
1980-77	All Models (Inc Calif)	5.0L(F) 302"(VV) 5.8L(H) 351"(VV) (C.T. Tag 7-40MF, 7-85MF, 7060KH350, 7090KE375)	F-2	D7ZZ-9848-A, E; D9AZ-D, E0AZ-G	102-1066
1980-77	All Models (Inc Hi-Alt)	5.0L(F) 302" 5.8L(G,H) 351" 6.6L(S) 400" (C.T. Tag 2AB4, 2EB4, 2FB4, 2LB4, 26B4, 2-65MF, 2-650D, 2100ME)	F-2	D3AZ-9848-N, D5AZ-A, C; D5OZ-A, D7AZ-A, D; D7DZ-A, D7TZ-A, D84Z-A	102-1008
1980-77	All Models	5.0L(F) 302" 5.8L(G,H) 351" (C.T. Tag TB3, TB4, TB5, TW, TX, TY)	F-2	C6AZ-9848-A, D0AZ-G, D1AZ-A, B, C; D2AZ-B	102-1007
1971-65	All Models	5.0L(G,J) 302" 5.8L(M) 351"	H-4	B8A-9848-E, 47R-116A	102-1068
1980	All Models	5.8L(G) 351"(VV) (C.T. Tag EOAE-HA)	F-2	E0AZ-9848-D	102-1080
1978-73	Lincoln, Mark	7.5L(A,C) 460" (C.T. Tag 2AB4, 2EB4, 2FB4, 4AB5)	F-4	D3AZ-9848-N, D5AZ-A, D5VZ-C, D7PZ-D	102-1008
1974-70	Lincoln, Mark	7.5L(A,C) 460" (C.T. Tag TN, TO, 4TY)	F-4	C4AZ-9848-A, B; D0AZ-D	102-1007

MAZDA

4 CYLINDER

1990-80	All Models	(Small Diameter Choke)		MI-SL	85-351
1990-80	All Models	(Large Diameter Choke)		MI-SL	85-350

MERCURY

4 CYLINDER

1985-84	All Models (All Tran.)	1.6L(2) 98" (C.T. Tag 47R-711-1A, 3A, 4A)	W-2	E4PZ-9848-B, C, D	102-1069
1983-82	All Models (All Tran.)(Inc Canada)	1.6L(2,4) 98" (C.T. Tag 47R-688A, 1A, 706-1A, 2A, 3A, 4A)	W-2	E3PZ-9848-H, K, L, M	102-1035
1982	All Models (All Tran.)	1.6L(4) 98" (C.T. Tag 47R-674A, 1A)	W-2	E1PZ-9848-C, G	102-1029
1985-84	All Models	2.3L(R) 140" (HSC) (C.T. Tag 47R-696-4A)	H-1	E4PZ-9848-A	102-1034
1985-83	All Models (All Tran.)	2.3L(A,R) 140" (C.T. Tag RER3-06HS, 48HS)	C-1	E3PZ-9848-J, E4PZ-E	102-1032
1982-80	All Models	2.3L(A) 140"	H-2	E0PZ-9848-C, D	102-1023
1981-77	All Models (Inc Calif)	2.3L 140" (Turbo) (A,T,W,Y)	H-2	D8PZ-9848-D, E7FZ-A, E7PZ-A, 170-1528	102-1063

APPLICATION GUIDE

YEAR	VEHICLE MODEL	ENGINE DISP.	MFG. CODE	O.E.M. NO.	WALKER PART NO.
------	---------------	--------------	-----------	------------	-----------------

MERCURY (CONT'D)

6 CYLINDER

1979-74	All Models (All Tran.)(Inc Calif)	2.8L(P,Z) 171"(VV) (C.T. Tag 2AB4, 2EB4, 2FB4, 2LB4, 26B4)	F-2	D3AZ-9848-N, D5AZ-A, C; D5OZ-A, D7FZ-E	102-1008
1978-77	All Models (Inc Calif)	2.8L(Z) 171"(VV) (C.T. Tag 7-85MF)	F-2	D7ZZ-9848-E	102-1066
1974-70	All Models	2.8L(U) 170" 3.3L(T) 200" 4.1L(L) 250" (C.T. Tag U877, AJ877, AZ877)	C-1	D0DZ-9848-A, D0TZ-A, B; 170-1102, 04, 08	102-1010
1969-63	All Models	2.8L(U) 170" 3.3L(T) 200" (C.T. Tag TP)	F-1	C5OZ-9848-A	102-1031
1982	All Models (Inc Canada)	3.3L(B) 200" (C.T. Tag 47R-686-3A)	H-1	E2PZ-9848-K	102-1033
1982-78	All Models (All Tran.)	3.3L(B,T) 200"	H-1	E0PZ-9848-F, K; E1PZ-F, 45-266	102-1064
1980-78	All Models (All Tran.)(Inc Calif)	3.3L(B) 200" 4.1L(C,L) 250" (C.T. Tag EC1548A, ED1546A, 1545A)	C-1	D8PZ-9848-B, D9PZ-A, B, C; E0PZ-G, H; 170-1545, 46, 48, 53, 76	102-1065
1979-78	All Models (A/T)	3.3L(B) 200" (C.T. Tag 1-70L-J)	H-1	D8PZ-9848-E, D9PZ-F	102-1051
1978-74	All Models	3.3L(T) 200" 4.1L(L) 250" (C.T. Tag EC901A)	C-1	D4DZ-9848-C, D4TZ-E, 170-1232, 39	102-1027
1977	All Models	3.3L(T) 200" 4.1L(L) 250" (C.T. Tag AZ877, U877)	C-1	D0DZ-9848-A, D0TZ-A, B; 170-1102, 04, 08	102-1010
1986-85	All Models (Exc Canada)	3.8L(3) 232"	F-2, TBI	E35Y-9848-A	102-1017
1984-82	All Models (Inc Calif, Canada)	3.8L(C,3) 232" (C.T. Tag 2065KE350, 2080ME350, 400)	F-2	E2TZ-9848-A, E3SZ-B, E3TZ-B	102-1018
1982	All Models (Inc Calif)	3.8L(3) 232" (VV) (C.T. Tag 7090KD400)	F-2	E2DZ-9848-A	102-1017

8 CYLINDER

1963-62	All Models	3.6L 221" (C.T. Tag TB3, TB4, TB5, TW, TX, TY)	F-2	C6AZ-9848-A, D0AZ-G, D1AZ-A, B, C; D2AZ-B	102-1007
1983-81	All Models (A4OD)	4.2L(D) 255"(VV) (C.T. Tag 7090KD400, C100ME-4)	F-2, TBI	E1AZ-9848-E, E35Y-A, E5AE-EA	102-1017
1981-80	All Models	4.2L(D) 255" (C.T. Tag 2065ME350, 2080ME350, 2100ME400)	F-2	E0BZ-9848-B, E1BZ-E, E2BZ-D	102-1008
1971-60	All Models	4.3L 260" 4.7L(C) 289" 5.8L 352" 6.4L(H,Y,X) 390" (C.T. Tag TB3, TB4, TB5, TW, TX, TY)	F-2	C6AZ-9848-A, D0AZ-G, D1AZ-A, B, C; D2AZ-B	102-1007
1974-60	All Models	4.7L(A,K) 289" 5.0L(G) 302" 5.8L(R,Q) 351", 352" 6.4L(S,Z) 390" 7.0L(R,Q) 428" 7.0L 429" (C,J,K,N,O,Z) 7.5L(A) 460" (C.T. Tag TN, TO, 4TY)	F-4	C4AZ-9848-A, B; D0AZ-D	102-1007
1971-65	All Models	4.7L(A,K) 289" 5.0L(D,F) 302" 5.8L(M) 351"	H-4	B8A-9848-E, 47R-116A	102-1068
1991-81	All Models (A4OD)	5.0L(F) 302"(VV) 5.8L(G) 351"(VV) (C.T. Tag 7090KD400, C100ME-4)	F-2, TBI	E1AZ-9848-E, E35Y-A, E5AE-EA	102-1017

APPLICATION GUIDE

YEAR	VEHICLE MODEL	ENGINE DISP.	MFG. CODE	O.E.M. NO.	WALKER PART NO.
------	---------------	--------------	-----------	------------	-----------------

MERCURY

8 CYLINDER (CONT'D)

1985-84	Mustang (M/T)	5.0L(M) 302" (C.T. Tag 47R-764A)	H-4	E3PZ-9848-N, E4PZ-G	102-1075
1983	All Models (Inc Canada)	5.0L(F) 302"	F-2	E3AZ-9848-D	102-1018
1983-80	All Models	5.0L(F) 302" (C.T. Tag 2065ME350, 2080ME350, 2100ME400)	F-2	E0BZ-9848-B, E1BZ-E, E2BZ-D	102-1008
1982-77	All Models (Inc Calif)	5.0L(F) 302" (C.T. Tag 7-40MF, 7-85MF, 7060KH350, 7090KE375)	F-2	D7ZZ-9848-A, E; D9AZ-D, E0AZ-G	102-1066
1980-73	All Models (Inc Hi-Alt)	5.0L(F) 302" 5.8L(G,H,Q)351" 6.6L(S) 400" (C.T. Tag 2AB4, 2EB4, 2FB4, 2LB4, 26B4, 2-65MF, 2-500E, 2-650D, 2100ME)	F-2	D3AZ-9848-N, D5AZ-A, C; D5OZ-A, D7AZ-A, D; D7DZ-A, D7TZ-A, D84Z-A	102-1008
1980-62	All Models	5.0L(F) 302" 5.8L(G,H,Q) 351", 352" (C.T. Tag TB3, TB4, TB5, TW, TX, TY)	F-2	C6AZ-9848-A, D0AZ-G, D1AZ-A, B, C; D2AZ-B	102-1007
1983-80	All Models	5.8L(G) 351" (VV) (C.T. Tag 7080KD375)	F-2	E0AZ-9848-L	102-1067
1981-77	All Models (Inc Calif)	5.8L(G,H,Q) 351" (VV) (C.T. Tag 7-40MF, 7-85MF, 7060KH350, 7090KE375)	F-2	D7ZZ-9848-A, E; D9AZ-D, E0AZ-G	102-1066
1980	All Models	5.8L(G) 351" (VV) (C.T. Tag E0AE-HA)	F-2	E0AZ-9848-D	102-1080
1978-73	All Models	7.5L(A) 460" (C.T. Tag 2AB4, 2EB4, 2FB4, 4AB5)	F-4	D3AZ-9848-N, D5AZ-A, D5VZ-C, D7PZ-D	102-1008

MITSUBISHI

4 CYLINDER

1990-80	All Models	(Small Diameter Choke)		MI-SL	85-351
1990-80	All Models	(Large Diameter Choke)		MI-SL	85-350

OLDSMOBILE

4 CYLINDER

1982	Firenza (Inc Calif, Canada)	1.8L(G) 112"	R-2	17068690, 17078515, 816 W/Carb 17059327	102-1020
1984-83	Firenza (Inc Canada)	2.0L(B) 121"	R-2	17079669	102-1052
1976	All Models	2.3L(B) 140"	R-1	370707	102-1060
1981-79	Omega (Inc Calif)	2.5L 151" (V,1,5,9)	R-2	17061093, 959; 17063188, 17064307, 560, 998; 17067728, 17070172	102-1020
1979-78	All Models (Inc Calif)	2.5L(V,1) 151"	H-2	10003439, 10003440, 10003441	102-1058

6 CYLINDER

1986-80	Ciera, Omega (Inc Calif)	2.8L(7,X,Z) 173"	R-2	17062601, 17063239, 17067579, 580; 17068743, 753; 17079156, 781	102-1020
1985-84	Ciera, Cutlass, Delta 88, 98 (Inc Calif)	3.0L(E) 181"	R-2	17068871, 914	102-1019
1987-80	Ciera, Cutlass, Delta 88, 98 (Inc Calif)	3.8L(A) 231"	R-2	17067207, 17068871, 914	102-1019
1981-80	Cutlass, Starfire (Inc Calif)	3.8L(A) 231"	R-2	17064106, 17067329, 437	102-1072
1979	Cutlass, Delta 88, Omega, Starfire	3.8L(A,2) 231"	R-2	17062235, 481	102-1039
1978-77	Cutlass, Delta 88, Omega, Starfire (Inc Calif)(Hi-Alt)	3.8L(A,C) 231"	R-2	17054594, 17058794, 17060913	102-1036
1976-75	All Models	3.8L(C) 231" (W/Integral Style)	R-2	17052512	102-1005
1984-82	Toronado, 98 (Inc Calif)	4.1L(4) 252"	R-4	17068871, 914	102-1019
1976-75	All Models	4.1L(D) 250" (W/Integrated Cyl. Head)	R-1	17052651	102-1057
1975-73	Omega	4.1L(D) 250"	R-1	333992, 362710, 3998143	102-1002

APPLICATION GUIDE

YEAR	VEHICLE MODEL	ENGINE DISP.	MFG. CODE	O.E.M. NO.	WALKER PART NO.
------	---------------	--------------	-----------	------------	-----------------

OLDSMOBILE

6 CYLINDER (CONT'D)

1971-66	F-85, Cutlass (All Tran.)	4.1L(D)	250"	R-1	3821564, 3927770, 772; 9783047, 9792129	102-1024
---------	---------------------------	---------	------	-----	--	----------

8 CYLINDER

1981	Toronado, 98	4.1L(4)	252"	R-4	17067329, 437	102-1072
1982	Custom Cruiser, Cutlass, Delta 88, Toronado, 98 (Inc Canada)	4.3L(8)	260"	R-4	17068982, 17110646 W/Carb 17084256, 258	102-1012
1982-80	All Models	4.3L(8,F)	260"	R-2, 4	17066680, 17067932, 17068941	102-1012
1979-75	All Models	4.3L(F) 5.0L(Y)	260" 301"	R-2, 4	7036948, 17051900, 964, 995; 17052585, 17054309, 17055175	102-1006
1990-82	Custom Cruiser, Cutlass, Delta 88, Toronado 98 (Inc Canada)	5.0L(Y,9)	307"	R-4	17068982, 17110646 W/Carb 17084256, 258	102-1012
1986-85	Cutlass (Canada)	5.0L(H)	305"	R-4	17110879, 994	102-1019
1984-80	All Models	5.0L(Y,9)	307"	R-2, 4	17066680, 17067932, 17068941	102-1012
1980	Cutlass (Inc Calif)	5.0L(H)	305"	R-4	17063451, 17064029, 215, 473; 17070300	102-1019
1979-75	All Models	5.7L (J,K,L,R)(W/Integral Style)	350"	R-2, 4	17051918	102-1005
1977-75	All Models	5.7L (J,K,L,R)(W/Integral Style)	350"	R-4	17052654, 784	102-1021
1976-75	All Models	5.7L (J,K,R)(W/Integral Style)	350"	R-2	17052512	102-1005
1976-71	All Models (Inc Calif)	5.7L (J,K,M,R)(W/Integral Style)	350"	R-4	7036881, 948; 17051900, 956, 995; 17052585, 640; 17054309	102-1006
1976-71	All Models (Inc Calif)	7.5L (T,U,V,W,X)(W/Integral Style)	455"	R-4	7036881, 948; 17051900, 956, 995; 17052585, 640; 17054309	102-1006

PLYMOUTH

4 CYLINDER

1980	All Models (Inc Calif, Canada)	1.6L(K) 1.7L(A)	98" 105"	H-2	4186295, 4240080, 4342867, 868	102-1013
1979-78	All Models	1.7L(A)	105"	HW-2	4131132	102-1058

6 CYLINDER

1969-62	All Models	2.7L(B) 3.7L(B)	170" 225"	C-1	2402526, 2658396, 170-760, 867	102-1042
1969-62	All Models	2.7L(B) 3.7L(B)	170" 225"	H-1	2532568, 2658398, R-3052A, R-3283-2A	102-1042
1973	All Models	3.2L(B)	198"	H-1	3698351, R-6434-1A	102-1056
1972-70	All Models	3.2L(B)	198"	H-1	3614111, 112; R-6222A	102-1025
1983-74	All Models	3.7L (C,E,F,G,H,J)	225"	H-1	3751476, 3830549, 4006669, 4027705, 4095330	102-1022
1980	All Models (Inc Canada)	3.7L(D)	225"	C-2	4095328	102-1003
1980-77	All Models	3.7L(D)	225"	C-2	4027707, 4095337, 170-1331, 1488	102-1049
1973	All Models	3.7L(C)	225"	H-1	3698351, R-6434-1A	102-1056
1972-70	All Models	3.7L(C)	225"	H-1	3614111, 112; R-6222A	102-1025

8 CYLINDER

1989-85	All Models (Exc Canada)	5.2L(P,4)	318"	H-2	4095339	102-1004
1984-73	All Models	5.2L (G,K,L,P,R,4)	318"	C-2	3698353, 3830512, 4027711, 4095338, 170-266, 982, 1332 W/Carb 8291	102-1004
1983-80	All Models (Exc Calif)	5.2L (G,K,L,P,4)	318"	C-2	4095329 W/Carb 8292, 8369	102-1004
1981	All Models (Inc Calif, Canada)	5.2L(M,N) (C.T. Tag BP 1621)	318"	C-4	3751484, 3830548, 4027715, 4095331, 341, 984; 170-861, 980, 1408, 1675	102-1003
1980	All Models (Inc Calif) All Models (Exc Calif)	5.2L(G) 5.9L(K)	318" 360"	C-2	4095328	102-1003
1979-74	All Models (Non-electric)	5.2L(G)	318"	C-2	3751479, 170-857	102-1014

APPLICATION GUIDE

YEAR	VEHICLE MODEL	ENGINE DISP.	MFG. CODE	O.E.M. NO.	WALKER PART NO.
------	---------------	--------------	-----------	------------	-----------------

PLYMOUTH

8 CYLINDER (CONT'D)

1979-73	All Models	5.2L(G) 5.9L(K) 6.6L(M)	318" 360" 400"	H-2	3698371, 3751480, 4027713, 4041834, 4095339, R-6416, R-6680-1A, 82A; R-7638AAA, R-7992A, 45-244	102-1004
1978-75	All Models (Non-electric)	5.2L(G)	318"	H-2	3751481, R-6681A	102-1014
1972-70	All Models (Inc Export)	5.2L(G)	318"	C-2	2946535, 2951651, 170-222, 232	102-1026
1971-70	All Models	5.6L(J)	340"	H-2	3614197, R-6199A, 1A	102-1046
1980-74	All Models	5.9L(J,L) 7.2L(T,U) (C.T. Tag BP 1621)	360" 400"	C-4	3751484, 3830548, 4027715, 4095331, 341, 984; 170-861, 980, 1408, 1675	102-1003
1980-73	All Models	5.9L(K)	360"	C-2	3698353, 3830512, 4027711, 4095338, 170-266, 982, 1332, W/Carb 8291	102-1004
1972-70	All Models	5.9L(K) 6.2L(L) 6.6L(M)	360" 383" 400"	H-2	3512872, R-4654A-1A	102-1043
1978-73	All Models (Inc Calif, Canada)	6.6L(N,P) (C.T. Tag BP 1621)	400"	C-4	3751484, 3830548, 4027715, 4095331, 341, 984; 170-861, 980, 1408, 1675	102-1003

PONTIAC

4 CYLINDER

1986-81	All Models (Inc Canada)	1.6L(9)	98"	H-2	14022274, 14050672, 14069855	102-1015
1982	J2000 (Inc Calif, Canada)	1.8L(G)	112"	R-2	17068690, 17078515, 690 Exc Carb 17082310, 311, 312, 315	102-1020
1984	J2000	2.0L(B)	121"	R-2	17079669	102-1052
1976-75	All Models	2.3L(A)	140"	R-1	348643, 72	102-1060
1981-79	Phoenix, Sunbird (Inc Calif)	2.5L(1,5)	151"	R-2	17061093, 959; 17063188, 17064307, 560, 998; 17067728, 17070172	102-1020
1979-78	All Models	2.5L(V,1)	151"	H-2	10003440	102-1058

6 CYLINDER

1987-80	Firebird, Phoenix, 6000 (All Tran.) (Inc Calif, Canada)	2.8L (1,7,L,X,Z)	173"	R-2	17062601, 17063239, 17067579, 580; 17068743, 753; 17078114, 17079061, 156, 306, 781, 782	102-1020
1984-83	Firebird (M/T)(Exc Canada)	2.8L (1,LX,Z)	173"	R-2	17078023	102-1052
1967-64	All Models (All Tran.)	3.5L 3.8L	215" 230"	R-1	3821564, 3927770, 772; 7029090, 9783047, 9792129, 133; 9797797, 798	102-1024
1987-80	Bonneville, Firebird, Grand Prix, LeMans, Parisienne	3.8L(K,9) 3.8L(A,3)	229" 231"	R-2	17063451, 960; 17064215, 473; 17068871, 914	102-1019
1981-80	Firebird, LeMans, Sunbird (Inc Calif)	3.8L(A)	231"	R-2	17064106, 17067329, 437	102-1072
1981-80	Firebird, Grand Prix, LeMans, Phoenix, Sunbird	3.8L(A)	231"	R-2	17062235, 481	102-1039
1978-77	Firebird, Grand Prix, LeMans, Phoenix, Sunbird, Ventura (Inc Calif)(Hi-Alt)	3.8L(A,C)	231"	R-2	17054594, 17058794, 17060913	102-1036
1976	All Models	3.8L(C) (W/Integral Style)	231"	R-2	17052512	102-1005
1982	Bonneville, Grand Prix (Inc Calif)	4.1L(4)	252"	R-4	17068871, 914	102-1019
1976-75	All Models	4.1L(D)	250"	R-1	17052651	102-1057
1976-72	All Models	4.1L(D)	250"	R-1	333992, 362710, 3998143	102-1002
1971-64	All Models (All Tran.)	4.1L	250"	R-1	3821564, 3927770, 772; 7029090, 9783047, 9792129, 133; 9797797, 798	102-1024

APPLICATION GUIDE

YEAR	VEHICLE MODEL	ENGINE DISP.	MFG. CODE	O.E.M. NO.	WALKER PART NO.
------	---------------	--------------	-----------	------------	-----------------

PONTIAC (CONT'D)

8 CYLINDER

1981	Firebird, Grand Prix, LeMans	4.3L(S) 265"	R-2	17067325	102-1019
1981-80	Firebird, Grand Prix, LeMans	4.3L(S) 265" 4.9L(T,W) 301"	R-2, 4	17064320, 17068413	102-1072
1976-73	All Models	4.3L(F) 260" 7.5L 455" (W,X,Y)	R-2, 4	7036881, 948; 17051900, 956, 964, 995; 17052585, 640; 17054309, 17055175, 640	102-1006
1981-80	Firebird, Grand Prix, LeMans	4.9L(T,W) 301"	R-2, 4	17063392, 17064320, 17067257, 17068413	102-1072
1981-80	Firebird, Grand Prix, LeMans	4.9L(T) 301" 5.0L(H) 305"	R-4	17064029, 17067325, 495; 17068292, 474; 17070300	102-1019
1989-86	Parisienne	5.0L(Y) 307"	R-4	17110646	102-1012
1987-85	Bonneville, Firebird, Grand Prix, Parisienne (Inc Canada)	5.0L(G,H) 305" 5.7L(6) 350"	R-4	17110879, 994	102-1019
1984-82	All Models	5.0L(G,H) 305"	R-4	17068956	102-1019
1981-80	All Models	5.0L(Y) 307" 5.7L(R,X) 350"	R-4	17066680, 17067932	102-1012
1981-73	All Models	5.0L 301" (T,W,Y) 6.6L(K) 403" 6.6L 400" (N,P,R,S,T,Z)	R-2, 4	7036881, 948; 17051900, 956, 964, 995; 17052585, 640; 17054309, 17055175, 640	102-1006
1978-77	LeMans (Inc Canada)	5.0L(U) 305" 5.7L(H,M) 350" (W/Integral Style)	R-2	17052654, 784	102-1021
1972-71	All Models	5.0L(F) 307"	R-2	3989058	102-1000
1979-75	All Models (Inc Canada)	5.7L 350" (H,J,P,R,X)(W/Integral Style)	R-4	17051918	102-1005
1979-73	All Models	5.7L 350" (A,B,E,H,J,K,L,M,N,P,R,X)	R-2, 4	7036881, 948; 17051900, 956, 964, 995; 17052585, 640; 17054309, 17055175, 640	102-1006
1976-75	All Models	5.7L(J,M) 350" (W/Integral Style)	R-2	17052512	102-1005
1972-71	All Models	5.7L 350" 6.6L 400" 7.5L 455"	R-2	482124, 125; 486249, 250; 487312, 488073	102-1011

O.E.M. INTERCHANGE

O.E.M. T-STAT	WALKER T-STAT	O.E.M. T-STAT	WALKER T-STAT	O.E.M. T-STAT	WALKER T-STAT	O.E.M. T-STAT	WALKER T-STAT	O.E.M. T-STAT	WALKER T-STAT
AMC		CARTER (CONT'D)		CARTER (CONT'D)		CHRYSLER (CONT'D)		FORD (CONT'D)	
4488063	102-1009	170-1409	102-1077	170-1770	102-1023	3698335	102-1003	D0DZ-9848-B	102-1010
4489439	102-1009	170-1411	102-1022	170-1771	102-1064	3698351	102-1056	D0TZ-9848-A	102-1010
8122959	102-1007	170-1426	102-1065	170-1772	102-1064	3698353	102-1004	D0TZ-9848-B	102-1010
8125121	102-1028	170-1427	102-1065	170-1773	102-1029	3698355	102-1003	D1AZ-9848-A	102-1007
8127327	102-1028	170-1428	102-1065	170-1774	102-1064	3698357	102-1004	D1AZ-9848-B	102-1007
8130222	102-1028	170-1488	102-1049	170-1775	102-1029	3698371	102-1004	D1AZ-9848-C	102-1007
8132544	102-1050	170-1489	102-1004	170-1777	102-1029	3751476	102-1022	D2AZ-9848-B	102-1007
8132548	102-1050	170-1490	102-1003	170-1780	102-1015	3751478	102-1004	D3AZ-9848-N	102-1008
8132716	102-1020	170-1511	102-1022	170-1825	102-1012	3751479	102-1014	D4AZ-9848-A	102-1008
8132751	102-1020	170-1512	102-1004	170-1826	102-1008	3751480	102-1004	D4DZ-9848-C	102-1027
8983501018	102-1052	170-1528	102-1063	170-1827	102-1008	3751481	102-1014	D4PZ-9848-G	102-1010
		170-1544	102-1065	170-1828	102-1008	3751482	102-1004	D4PZ-9848-J	102-1010
CARTER		170-1545	102-1065	170-1829	102-1067	3751484	102-1003	D4PZ-9848-Z	102-1010
170-15	102-1016	170-1546	102-1065	170-1830	102-1017	3830512	102-1004	D4TZ-9848-A	102-1008
170-16	102-1016	170-1548	102-1065	170-1831	102-1017	3830548	102-1003	D4TZ-9848-E	102-1027
170-44	102-1016	170-1553	102-1065	170-1832	102-1033	3830549	102-1022	D5AZ-9848-A	102-1008
170-50	102-1032	170-1559	102-1006	170-1833	102-1034	4006669	102-1022	D5AZ-9848-C	102-1008
170-222	102-1026	170-1562	102-1011	170-1834	102-1069	4027705	102-1022	D5OZ-9848-A	102-1008
170-232	102-1026	170-1564	102-1007	170-1835	102-1069	4027707	102-1049	D5VZ-9848-C	102-1008
170-236	102-1004	170-1565	102-1006	170-1836	102-1069	4027711	102-1004	D6AZ-9848-A	102-1007
170-266	102-1004	170-1567	102-1058	170-1837	102-1035	4027713	102-1004	D7AZ-9848-A	102-1008
170-334	102-1003	170-1569	102-1064	170-1838	102-1035	4027714	102-1003	D7AZ-9848-D	102-1008
170-760	102-1042	170-1574	102-1014	170-1839	102-1035	4027715	102-1003	D7DZ-9848-A	102-1008
170-796	102-1004	170-1576	102-1065	170-1840	102-1035	4027792	102-1003	D7FZ-9848-A	102-1063
170-857	102-1014	170-1578	102-1050	170-1841	102-1035	4027793	102-1003	D7FZ-9848-E	102-1008
170-859	102-1003	170-1596	102-1050	170-1842	102-1035	4027795	102-1077	D7PZ-9848-A	102-1063
170-861	102-1003	170-1598	102-1003	170-1843	102-1075	4041597	102-1014	D7PZ-9848-D	102-1008
170-867	102-1042	170-1599	102-1004	170-1844	102-1018	4041600	102-1062	D7TZ-9848-A	102-1008
170-868	102-1042	170-1621	102-1003	170-1845	102-1022	4041834	102-1004	D7ZZ-9848-A	102-1066
170-980	102-1003	170-1654	102-1015	170-1846	102-1015	4095328	102-1003	D7ZZ-9848-E	102-1066
170-982	102-1004	170-1655	102-1058	170-1847	102-1006	4095329	102-1004	D8PZ-9848-A	102-1065
170-983	102-1042	170-1658	102-1022	170-1848	102-1006	4095330	102-1022	D8PZ-9848-B	102-1065
170-1079	102-1009	170-1660	102-1004	170-1849	102-1018	4095331	102-1003	D8PZ-9848-D	102-1063
170-1080	102-1009	170-1661	102-1004	170-1850	102-1018	4095332	102-1022	D8PZ-9848-E	102-1051
170-1102	102-1010	170-1663	102-1006	170-1851	102-1018	4095335	102-1022	D8AZ-9848-A	102-1008
170-1104	102-1010	170-1672	102-1030	170-1852	102-1018	4095336	102-1022	D9AZ-9848-D	102-1066
170-1107	102-1010	170-1673	102-1030	170-1853	102-1017	4095337	102-1049	D9PZ-9848-A	102-1065
170-1108	102-1010	170-1675	102-1003	170-1854	102-1008	4095338	102-1004	D9PZ-9848-B	102-1065
170-1192	102-1004	170-1739	102-1003	170-8506	102-1032	4095339	102-1004	D9PZ-9848-C	102-1065
170-1232	102-1027	170-1740	102-1012	170-8548	102-1032	4095340	102-1004	D9PZ-9848-D	102-1065
170-1239	102-1027	170-1741	102-1012	CHRYSLER		4095341	102-1003	D9PZ-9848-F	102-1051
170-1245	102-1031	170-1742	102-1012	2402526	102-1042	4095431	102-1003	D9UZ-9848-A	102-1008
170-1246	102-1004	170-1743	102-1061	2402528	102-1042	4095450	102-1014	D94Y-9848-A	102-1066
170-1271	102-1007	170-1744	102-1061	2465086	102-1042	4095984	102-1003	E0AZ-9848-D	102-1080
170-1272	102-1007	170-1745	102-1008	2532209	102-1042	4131132	102-1058	E0AZ-9848-E	102-1066
170-1284	102-1007	170-1747	102-1008	2532568	102-1042	4186295	102-1013	E0AZ-9848-G	102-1066
170-1294	102-1008	170-1748	102-1008	2658396	102-1042	4213715	102-1022	E0AZ-9848-L	102-1067
170-1299	102-1022	170-1750	102-1008	2658397	102-1042	4240080	102-1013	E0BZ-9848-B	102-1008
170-1321	102-1028	170-1751	102-1008	2658398	102-1042	4342867	102-1013	E0DZ-9848-A	102-1008
170-1331	102-1049	170-1752	102-1008	2946522	102-1046	4342868	102-1013	E0PZ-9848-C	102-1023
170-1332	102-1004	170-1753	102-1008	2946532	102-1046	4488063	102-1009	E0PZ-9848-D	102-1023
170-1334	102-1003	170-1754	102-1008	2946535	102-1026	4489439	102-1009	E0PZ-9848-F	102-1064
170-1348	102-1062	170-1755	102-1008	2946537	102-1043	4549204	102-1013	E0PZ-9848-G	102-1065
170-1358	102-1006	170-1756	102-1008	2946549	102-1025	FORD		E0PZ-9848-H	102-1065
170-1360	102-1006	170-1757	102-1008	2951651	102-1026	B8A-9848-E	102-1068	E0PZ-9848-J	102-1064
170-1367	102-1060	170-1758	102-1066	3418501	102-1025	C4AZ-9848-A	102-1007	E0PZ-9848-K	102-1064
170-1368	102-1057	170-1759	102-1067	3418502	102-1025	C4AZ-9848-B	102-1007	E0PZ-9848-S	102-1029
170-1371	102-1014	170-1760	102-1066	3512843	102-1046	C5OZ-9848-A	102-1031	E0PZ-9848-U	102-1029
170-1371	102-1014	170-1761	102-1008	3512872	102-1043	C6AZ-9848-A	102-1007	E0TZ-9848-A	102-1008
170-1395	102-1004	170-1762	102-1066	3614111	102-1025	D0AZ-9848-A	102-1007	E0VY-9848-A	102-1066
170-1396	102-1005	170-1764	102-1022	3614112	102-1025	D0AZ-9848-D	102-1007	E1AZ-9848-C	102-1017
170-1398	102-1021	170-1765	102-1022	3614197	102-1025	D0AZ-9848-G	102-1007	E1AZ-9848-E	102-1017
170-1399	102-1006	170-1768	102-1013			D0DZ-9848-A	102-1010	E1BZ-9848-E	102-1008
170-1400	102-1005	170-1769	102-1013						
170-1407	102-1003								
170-1408	102-1003								

O.E.M. INTERCHANGE

O.E.M. T-STAT	WALKER T-STAT	O.E.M. T-STAT	WALKER T-STAT	O.E.M. T-STAT	WALKER T-STAT	O.E.M. T-STAT	WALKER T-STAT	O.E.M. T-STAT	WALKER T-STAT
FORD (CONT'D)		HOLLEY		ROCHESTER (CONT'D)		ROCHESTER (CONT'D)		ROCHESTER (CONT'D)	
E1PZ-9848-A	102-1030	R-2541A	102-1042	3887148	102-1040	17056750	102-1070	17068153	102-1020
E1PZ-9848-C	102-1029	R-2728A	102-1042	3888108	102-1024	17056849	102-1070	17068292	102-1019
E1PZ-9848-E	102-1030	R-3036A	102-1042	3908966	102-1041	17056852	102-1070	17068413	102-1072
E1PZ-9848-F	102-1064	R-3052A	102-1042	3927190	102-1001	17057936	102-1038	17068474	102-1019
E1PZ-9848-G	102-1029	R-3283-2A	102-1042	3927770	102-1024	17058794	102-1036	17068690	102-1020
E1TZ-9848-A	102-1067	R-4384A,1A	102-1025	3927772	102-1024	17058954	102-1070	17068743	102-1020
E1TZ-9848-B	102-1067	R-4385A,1A	102-1025	3946093	102-1001	17059968	102-1038	17068753	102-1020
E2AZ-9848-B	102-1008	R-4390A,1A	102-1043	3951638	102-1001	17060913	102-1036	17068772	102-1052
E2BZ-9848-D	102-1008	R-4395A,1A	102-1046	3969825	102-1040	17061093	102-1020	17068871	102-1019
E2BZ-9848-G	102-1008	R-4654	102-1043	3972186	102-1040	17061327	102-1039	17068914	102-1019
E2DZ-9848-A	102-1017	R-4654A,1A	102-1043	3973497	102-1001	17061395	102-1039	17068941	102-1012
E2DZ-9848-B	102-1018	R-6115A,1A	102-1046	3980236	102-1011	17061959	102-1020	17068956	102-1019
E2PZ-9848-A	102-1016	R-6199A,1A	102-1046	3980232	102-1011	17062081	102-1039	17068982	102-1012
E2PZ-9848-C	102-1035	R-6222A,1A	102-1025	3980242	102-1011	17062081	102-1039	17068982	102-1012
E2PZ-9848-D	102-1035	R-6223A,1A	102-1025	3989058	102-1000	17062235	102-1039	17068988	102-1019
E2PZ-9848-F	102-1016	R-6416	102-1004	3989060	102-1002	17062258	102-1039	17070042	102-1072
E2PZ-9848-J	102-1016	R-6416A	102-1004	3989625	102-1054	17062481	102-1039	17070172	102-1020
E2PZ-9848-K	102-1033	R-6434-1A	102-1056	3992082	102-1041	17062597	102-1037	17070300	102-1019
E2SZ-9848-A	102-1017	R-6676A	102-1022	3998143	102-1002	17062601	102-1020	17078012	102-1052
E2SZ-9848-B	102-1018	R-6680	102-1004	3998168	102-1060	17062957	102-1037	17078023	102-1052
E2TZ-9848-A	102-1018	R-6680A,1A	102-1004	3998169	102-1060	17063004	102-1039	17078114	102-1020
E2TZ-9848-C	102-1067	R-6681A	102-1014	3998170	102-1060	17063005	102-1039	17078213	102-1020
E2TZ-9848-D	102-1008	R-6682	102-1004	3998940	102-1002	17063188	102-1020	17078515	102-1020
E3AZ-9848-D	102-1018	R-6882A	102-1004	3999279	102-1041	17063239	102-1020	17078530	102-1052
E3PZ-9848-A	102-1053	R-6932A	102-1022	6262984	102-1000	17063392	102-1072	17078690	102-1020
E3PZ-9848-B	102-1032	R-7369A	102-1022	6272732	102-1054	17063451	102-1019	17078726	102-1073
E3PZ-9848-C	102-1053	R-7637AAA	102-1022	6272736	102-1054	17063693	102-1020	17078816	102-1020
E3PZ-9848-D	102-1053	R-7638AAA	102-1004	6273474	102-1060	17063753	102-1020	17079035	102-1019
E3PZ-9848-E	102-1074	R-7639A	102-1022	6273476	102-1060	17063957	102-1072	17079061	102-1020
E3PZ-9848-F	102-1016	R-7992A	102-1004	7029090	102-1024	17063960	102-1019	17079066	102-1020
E3PZ-9848-H	102-1035	R-8183A	102-1014	7036881	102-1006	17064029	102-1019	17079107	102-1052
E3PZ-9848-J	102-1032	R-8537A	102-1022	7036948	102-1006	17064106	102-1072	17079156	102-1020
E3PZ-9848-K	102-1035	R-8538A	102-1022	7043450	102-1038	17064207	102-1072	17079158	102-1020
E3PZ-9848-L	102-1035	R-8540A	102-1004	7046739	102-1054	17064215	102-1019	17079306	102-1020
E3PZ-9848-M	102-1035	45-244	102-1004	9783047	102-1024	17064307	102-1020	17079662	102-1037
E3PZ-9848-N	102-1075	45-266	102-1064	9792129	102-1024	17064320	102-1072	17079669	102-1052
E3SZ-9848-B	102-1018	47R-116A	102-1068	9792133	102-1024	17064473	102-1019	17079963	102-1052
E3TZ-9848-A	102-1018			9797797	102-1024	17064560	102-1020	17079781	102-1020
E3TZ-9848-B	102-1018			9797798	102-1024	17064988	102-1072	17079782	102-1020
E3TZ-9848-C	102-1018	JEEP		10003439	102-1058	17064998	102-1020	17110157	102-1012
E3TZ-9848-D	102-1018	4488063	102-1009	10003440	102-1058	17065043	102-1006	17110646	102-1012
E3TZ-9848-E	102-1018	4489439	102-1009	10003441	102-1058	17065388	102-1006	17110653	102-1019
E3TZ-9848-F	102-1018	8122959	102-1007	14012911	102-1015	17066074	102-1006	17110879	102-1019
E3TZ-9848-G	102-1018	8127327	102-1028	14022274	102-1015	17066631	102-1012	17110913	102-1019
E3UZ-9848-A	102-1018	8132544	102-1050	14050672	102-1015	17066634	102-1012	17110960	102-1019
E35Y-9848-A	102-1017	8132548	102-1050	14069855	102-1015	17066642	102-1061	17110994	102-1019
E4PZ-9848-A	102-1034	89 83 50108	102-1052	17051900	102-1006	17066680	102-1012		
E4PZ-9848-B	102-1069			17051918	102-1005	17066694	102-1061		
E4PZ-9848-C	102-1069	ROCHESTER		17051956	102-1006	17066780	102-1012		
E4PZ-9848-D	102-1069	326079	102-1002	17051964	102-1006	17066792	102-1012		
E4PZ-9848-E	102-1032	326096	102-1000	17051965	102-1006	17067137	102-1019		
E4PZ-9848-F	102-1075	333992	102-1002	17051995	102-1006	17067207	102-1019		
E4PZ-9848-G	102-1075	348643	102-1060	17052512	102-1005	17067209	102-1012		
E4TZ-9848-A	102-1018	348672	102-1060	17052585	102-1006	17067257	102-1072		
E5AE-9848-EA	102-1017	362710	102-1002	17052640	102-1006	17067325	102-1019		
E5PZ-9848-A	102-1075	370707	102-1060	17052651	102-1057	17067329	102-1072		
E5PZ-9848-B	102-1075	460110	102-1011	17052654	102-1021	17067437	102-1072		
E6PZ-9848-A	102-1069	482124	102-1011	17052784	102-1021	17067495	102-1019		
E6PZ-9848-B	102-1075	482125	102-1011	17053419	102-1038	17067579	102-1020		
E7AZ-9848-A	102-1063	483249	102-1011	17054309	102-1006	17067580	102-1020		
E7FZ-9848-A	102-1063	486250	102-1011	17054594	102-1036	17067727	102-1020		
E7PZ-9848-A	102-1063	487312	102-1011	17055175	102-1006	17067728	102-1020		
		488073	102-1011	17055241	102-1006	17067743	102-1020		
		488241	102-1011	17055640	102-1006	17067932	102-1012		
		3821564	102-1024						



102-1000 (R-2)
CHEVROLET (8) 1971-74
CHEV/GMC TRUCK (8) 1971-74
PONTIAC (8) 1971-72



102-1004 (C-2, H-2)
CHRYSLER (8) 1973-89
DODGE (8) 1973-89
DODGE TRUCK (8) 1973-87
PLYMOUTH (8) 1973-89



102-1008 (F-2, 4)
FORD (6, 8) 1973-83
FORD TRUCK (8) 1973-83
LINCOLN (8) 1973-80
MERCURY (6, 8) 1973-83

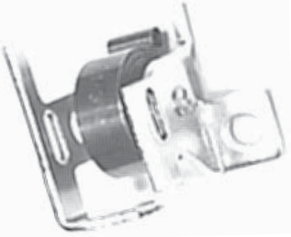

102-1001 (R-4)
CHEVROLET (8) 1967-70
CHEV/GMC TRUCK (8) 1968-70



102-1005 (R-2, 4)
BUICK (6, 8) 1975-76
CHEVROLET (8) 1975-79
CHEV/GMC TRUCK (8) 1977-79
OLDSMOBILE (6, 8) 1975-76
PONTIAC (6, 8) 1976



102-1009 (C-1)
AMC (6) 1970-79
FORD TRUCK (6) 1980
JEEP (6) 1972-78



102-1002 (R-1, 4)
BUICK (6) 1973-75
CHEVROLET (6, 8) 1971-76
CHEV/GMC TRUCK (6, 8) 1971-78
OLDSMOBILE (6) 1973-75
PONTIAC (6) 1972-76



102-1006 (R-2, 4)
BUICK (8) 1975-79
CHEVROLET (8) 1975-79
CHEV/GMC TRUCK (8) 1976-80
OLDSMOBILE (8) 1971-79
PONTIAC (8) 1973-81



102-1010 (C-1)
FORD (6) 1970-77
FORD TRUCK (6) 1970-86
MERCURY (6) 1970-77

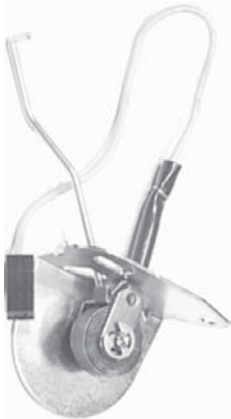

102-1003 (C-2, 4)
CHRYSLER (6, 8) 1974-82
DODGE (6, 8) 1973-81
DODGE TRUCK (8) 1974-86
PLYMOUTH (6, 8) 1973-81



102-1007 (F-2, 4)
AMC (8) 1973-78
FORD (8) 1960-80
FORD TRUCK (6, 8) 1970-85
JEEP (8) 1973-79
LINCOLN (8) 1970-80
MERCURY (8) 1960-80



102-1011 (R-2, 4)
CHEV/GMC TRUCK (8) 1977-78



102-1012 (R-2, 4)
 BUICK (8) 1981-90
 CADILLAC (8) 1986-90
 CHEVROLET (8) 1986-90
 CHEV/GMC TRUCK (8) 1980-84
 OLDSMOBILE (8) 1980-90
 PONTIAC (8) 1980-89



102-1016 (C-1)
 FORD TRUCK (6) 1982-86

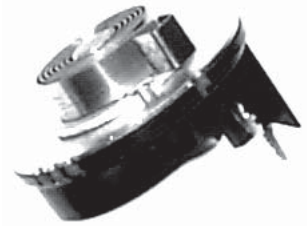

102-1020 (R-2, 4)
 AMC (4) 1980
 BUICK (4, 6) 1980-86
 CADILLAC (4, 8) 1980, 1982
 CHEVROLET (4, 6) 1979-86
 CHEV/GMC TRUCK (6) 1980-85
 JEEP (4, 6) 1980, 1984-86
 OLDSMOBILE (4, 6) 1979-86
 PONTIAC (4, 6) 1979-87

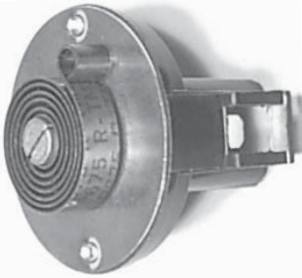

102-1013 (H-2)
 CHRYSLER (4) 1982-84
 DODGE (4) 1980
 DODGE TRUCK (4) 1984-88
 PLYMOUTH (4) 1980



102-1017 (F-2)
 FORD (6, 8) 1960-86
 LINCOLN (6, 8) 1981-91
 MERCURY (6, 8) 1981-91



102-1021 (R-2, 4)
 BUICK (8) 1977-78
 CHEVROLET (8) 1975-78
 CHEV/GMC TRUCK (8) 1975-78
 OLDSMOBILE (8) 1974-77
 PONTIAC (8) 1977-78



102-1014 (C-2, 4; H-2)
 CHRYSLER (8) 1975-79
 DODGE (8) 1974-79
 DODGE TRUCK (8) 1974-84
 PLYMOUTH (8) 1974-79



102-1018 (F-2)
 FORD (6, 8) 1982-85
 FORD TRUCK (6, 8) 1982-86
 LINCOLN (6) 1983
 MERCURY (6, 8) 1982-84



102-1022 (H-1)
 CHRYSLER (6) 1977-84
 DODGE (6) 1974-83
 DODGE TRUCK (6) 1974-87
 PLYMOUTH (6) 1974-83



102-1015 (HW-2)
 CHEVROLET (4) 1979-88
 PONTIAC (4) 1981-86

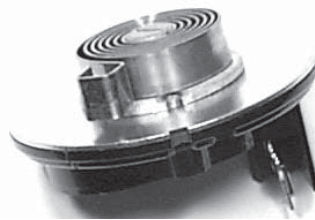

102-1019 (R-2, 4)
 BUICK (6, 8) 1980-87
 CADILLAC (6) 1982-83
 CHEVROLET (6, 8) 1980-88
 CHEV/GMC TRUCK (6, 8) 1980-89
 OLDSMOBILE (6, 8) 1980-87
 PONTIAC (6, 8) 1980-87



102-1023 (H-2)
 FORD (4) 1980-82
 MERCURY (4) 1980-82

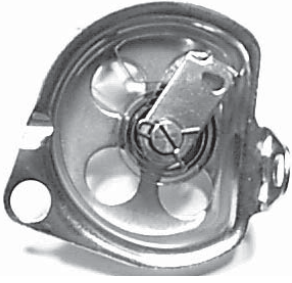

102-1024 (R-1)
 BUICK (6) 1968-71
 CHEVROLET (4, 6) 1963-70
 CHEV/GMC TRUCK (6) 1969-71
 OLDSMOBILE (6) 1966-71
 PONTIAC (6) 1964-71



102-1028 (C-2)
 AMC (6) 1976-79
 JEEP (6) 1977-79



102-1033 (H-1)
 FORD (6) 1982-83
 MERCURY (6) 1982



102-1025 (H-1)
 DODGE (6) 1970-72
 DODGE TRUCK (6) 1970-71
 PLYMOUTH (6) 1970-72



102-1029 (W-2)
 FORD (4) 1981-82
 MERCURY (4) 1982



102-1034 (H-1)
 FORD (4) 1984-85
 MERCURY (4) 1984-85



102-1030 (C-1)
 FORD TRUCK (6) 1981



102-1035 (W-2)
 FORD (4) 1982-83
 MERCURY (4) 1982-83

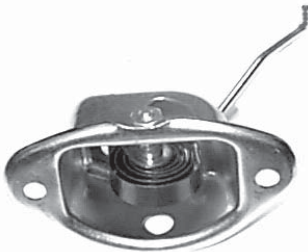

102-1026 (C-2)
 DODGE (8) 1970-72
 DODGE TRUCK (8) 1970-74
 PLYMOUTH (8) 1970-72



102-1031 (F-1)
 FORD (6) 1963-69
 MERCURY (6) 1963-69



102-1036 (R-2)
 BUICK (6) 1977-78
 CHEVROLET (6) 1978
 CHEV/GMC TRUCK (6) 1978
 OLDSMOBILE (6) 1977-78
 PONTIAC (6) 1977-78



102-1027 (C-1)
 FORD (6) 1974-78
 FORD TRUCK (6) 1974-78
 MERCURY (6) 1974-78



102-1032 (C-1)
 FORD (4) 1983-85
 FORD TRUCK (4) 1983-86
 MERCURY (4) 1983-85

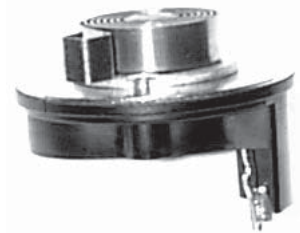

102-1037 (R-2)
 BUICK (6) 1983-85
 CHEVROLET (6) 1983
 CHEV/GMC TRUCK (6) 1979

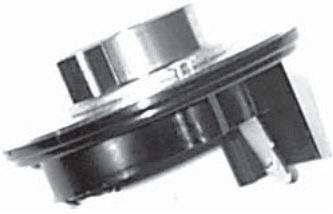

102-1038 (R-2, 4)
BUICK (6) 1978
CADILLAC (8) 1976-78
CHEVROLET (6, 8) 1976-78
CHEV/GMC TRUCK (6, 8) 1975-78



102-1042 (C-1, H-1)
DODGE (6) 1962-69
DODGE TRUCK (6) 1962-69
PLYMOUTH (6) 1962-69



102-1050 (C-2)
AMC (6) 1980
JEEP (6) 1980



102-1039 (R-2, 4)
BUICK (6) 1979
CADILLAC (8) 1979
CHEVROLET (6) 1979
CHEV/GMC TRUCK (6) 1979
OLDSMOBILE (6) 1979
PONTIAC (6) 1980-81



102-1043 (H-2)
CHRYSLER (8) 1971-72
DODGE (8) 1971-72
DODGE TRUCK (8) 1971-72
PLYMOUTH (8) 1970-72



102-1051 (H-1)
FORD (6) 1978-79
MERCURY (6) 1978-79



102-1040 (H-4, R-2, 4)
CHEVROLET (8) 1965-70
CHEV/GMC TRUCK (8) 1969



102-1046 (H-2)
DODGE (8) 1970-71
PLYMOUTH (8) 1970-71



102-1052 (R-2)
BUICK (4) 1984
CHEVROLET (4, 6) 1983-84
CHEV/GMC TRUCK (4, 6) 1982-84
JEEP (6) 1984-86
OLDSMOBILE (4) 1983-84
PONTIAC (4, 6) 1983-84



102-1041 (R-2)
CHEVROLET (6) 1963-70



102-1049 (C-2)
CHRYSLER (6) 1977-84
DODGE (6) 1977-80
DODGE TRUCK (6) 1978-83
PLYMOUTH (6) 1977-80



102-1053 (C-1)
FORD TRUCK (4) 1983

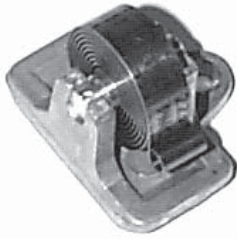

102-1054 (R-4)
 CHEVROLET (8) 1969-74
 CHEV/GMC TRUCK (8) 1970-76

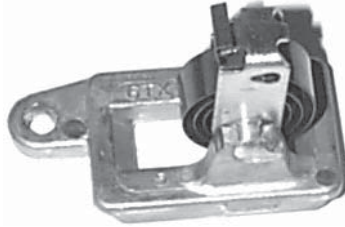

102-1060 (R-1, 2)
 CHEVROLET (4) 1971-76
 OLDSMOBILE (4) 1976
 PONTIAC (4) 1975-76



102-1064 (H-1)
 FORD (6) 1978-82
 MERCURY (6) 1978-82



102-1056 (H-1)
 DODGE (6) 1973
 DODGE TRUCK (6) 1973
 PLYMOUTH (6) 1973



102-1061 (R-2, 4)
 CHEV/GMC TRUCK (8) 1980



102-1065 (C-1)
 FORD (6) 1978-80
 FORD TRUCK (6) 1978-80
 MERCURY (6) 1978-80

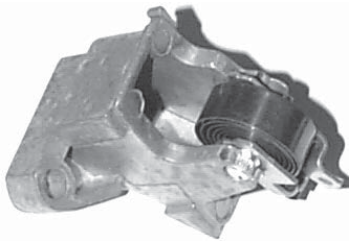

102-1057 (R-1)
 BUICK (6) 1975
 CHEVROLET (6) 1975-76
 CHEV/GMC TRUCK (6) 1975-76
 OLDSMOBILE (6) 1975-76
 PONTIAC (6) 1975-76



102-1062 (C-2)
 DODGE TRUCK (6) 1977-83



102-1066 (F-2)
 FORD (6, 8) 1977-81
 LINCOLN (8) 1977-80
 MERCURY (6, 8) 1977-82



102-1058 (HW-2)
 AMC (4) 1979
 CHEVROLET (4) 1978-79
 DODGE (4) 1978-79
 OLDSMOBILE (4) 1978-79
 PLYMOUTH (4) 1978-79
 PONTIAC (4) 1978-79

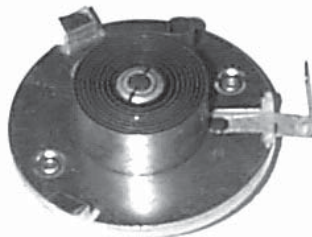

102-1063 (H-2)
 FORD (4) 1977-81
 MERCURY (4) 1977-81



102-1067 (F-2)
 FORD (8) 1980-83
 FORD TRUCK (8) 1981-83
 MERCURY (8) 1980-83



102-1068 (H-4)
 FORD (8) 1965-71
 FORD TRUCK (8) 1974-82
 LINCOLN (8) 1965-71
 MERCURY (8) 1965-71



102-1072 (R-2, 4)
 BUICK (6, 8) 1980-81
 CADILLAC (6, 8) 1980-81
 CHEVROLET (6, 8) 1980-81
 CHEV/GMC TRUCK (6) 1980-81
 OLDSMOBILE (6, 8) 1980-81
 PONTIAC (6, 8) 1980-81



102-1077 (C-4)
 DODGE TRUCK (8) 1978-80



102-1069 (W-2)
 FORD (4) 1984-85
 MERCURY (4) 1984-85



102-1073 (R-4)
 CHEV/GMC TRUCK (8) 1983-85



102-1080 (F-2)
 FORD (8) 1980
 LINCOLN (8) 1980
 MERCURY (8) 1980



102-1070 (R-1, 2)
 CHEVROLET (4, 6) 1977-78
 CHEV/GMC TRUCK (6) 1977-78



102-1074 (H-4)
 FORD TRUCK (8) 1983-85



85-350 (MI-SL)
 CHRYSLER IMPORT (4) 1980-90
 MAZDA (4) 1980-90
 MITSUBISHI (4) 1980-90



102-1071 (R-2)
 BUICK (8) 1979
 CHEVROLET (6) 1979
 CHEV/GMC TRUCK (6) 1979



102-1075 (H-4)
 FORD (8) 1983-85
 FORD TRUCK (8) 1983-86
 MERCURY (8) 1984-85



85-351 (MI-SL)
 CHRYSLER IMPORT (4) 1980-90
 MAZDA (4) 1980-90
 MITSUBISHI (4) 1980-90